

# OPERATING INSTRUCTIONS

Use these Operating Instructions to assemble and use the 6054 Network Control Module and the 6055 Docking Module.

The 6054 Network Control Module controls one to four 6055 Docking Modules, which provides Pathfinder® printers charging and Ethernet communication capability.

The 6054 Network Control Module and 6055 Docking Module can only be used with printers that contain the approved battery as listed in the printer documentation. Refer to the *Operator's Handbook* for additional important battery safety information.

Follow the operating and storage limit specifications listed at the end of these instructions. Otherwise, the battery may permanently lose its charge capacity.

Charge the printer before using it.

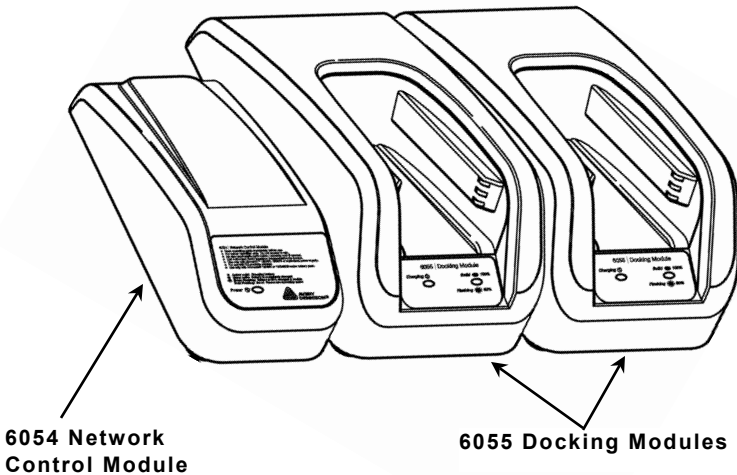

## Assembling the Network Control Module

---

1. Turn over the 6055 Docking Module and 6054 Network Control Module.
2. Using a Philips screwdriver, remove the end cap from the Network Control Module.

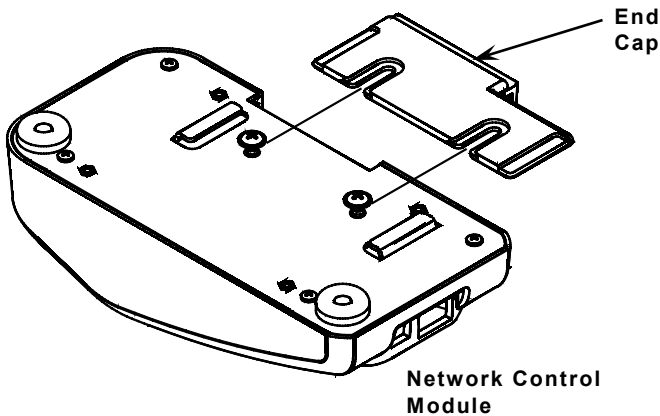

3. Using a Philips screwdriver, loosen two screws on the 6055 Docking Module and slide the connector plate under the screws. Tighten the screws.

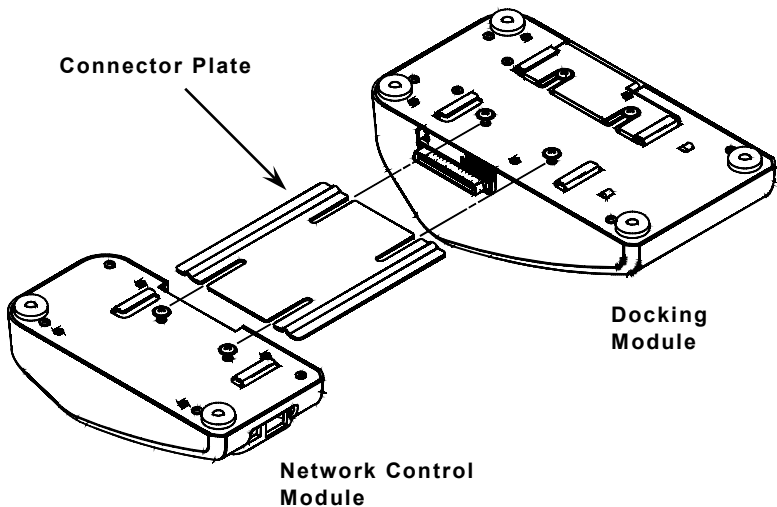

- Loosen the two screws on the 6054 Network Control Module and slide the 6054 Network Control Module onto the Docking Module's connector plate. Tighten the screws.

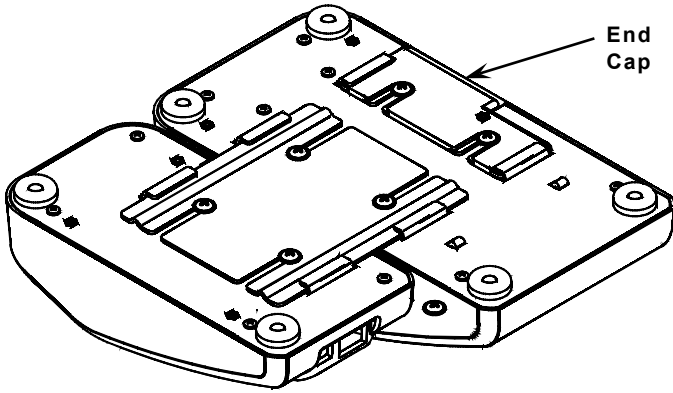

- Using a Philips screwdriver, attach the end cap to the end of the 6055 Docking Module.
- Carefully turn over the Network Control Module.

You can connect up to four Docking Modules with each Network Control Module. Repeat steps 3 – 6 for each additional Docking Module. Attach the end cap to the final Docking Module.

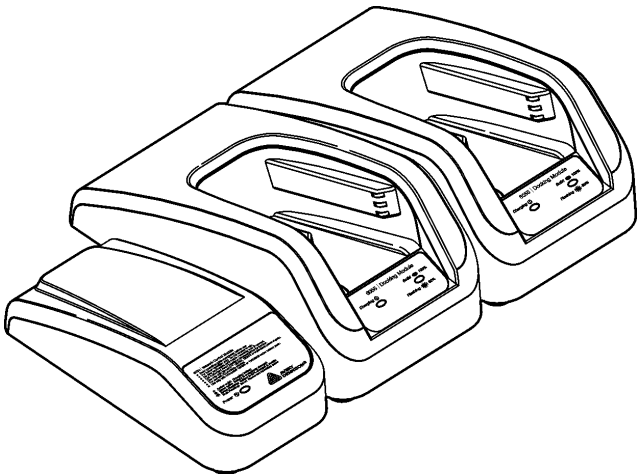

# Setting up the Network Control Module

---

1. Plug the supplied power cable into the Network Control Module.
2. Plug the other end of the cable into a grounded electrical outlet. The green power LED on the 6054 Network Control Module turns on.
3. Connect the communication cable from the host to the Network Control Module.

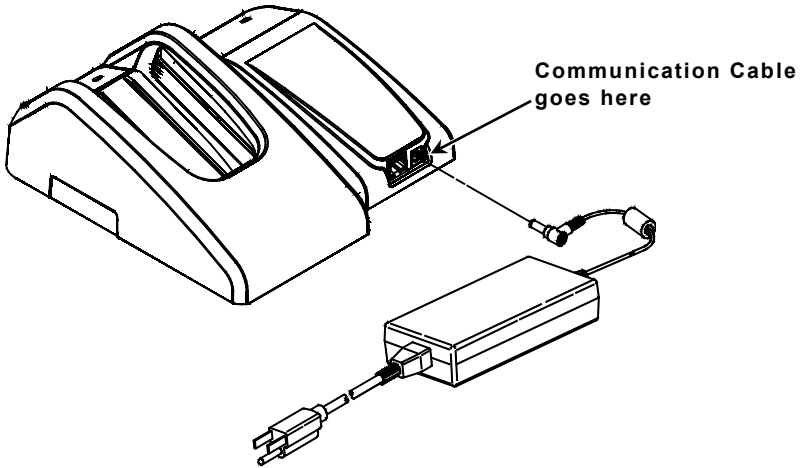

## For Use in Brazil

In order to meet the compliance requirements of Brazil, Network Module, whose model is 6054, should be fed by the source model:

FSP FSP084-DMAA1, Input: 100-240Vac, 50-60Hz, 1.3A, Output: 12Vdc, 7.0A, LPS. Or Edac Power Electronics Co.

And 10953A Input: 100-240Vac, 50-60Hz, 2.5A, Output: +12 Vdc, 6.6a, 80W, LPS. along with the surge protector model Clone F1W.

A fim de atender aos requisitos de conformidade do Brasil, o Network Module, cujo modelo é 6054, deve ser alimentado pela fonte de modelo:

FSP FSP084-DMAA1, Input: 100-240Vac, 50-60Hz, 1.3A, Output: 12Vdc, 7.0A, LPS. ou Edac Power Electronics Co., E 10953A Input: 100-240Vac, 50-60Hz, 2.5A, Output: +12Vdc, 6.6A, 80W, LPS

junto com o protetor de surto de modelo Clone F1W.

# Charging the Battery

Charge the battery while it is inside the printer. Slide the printer into the Docking Module until you hear a click.

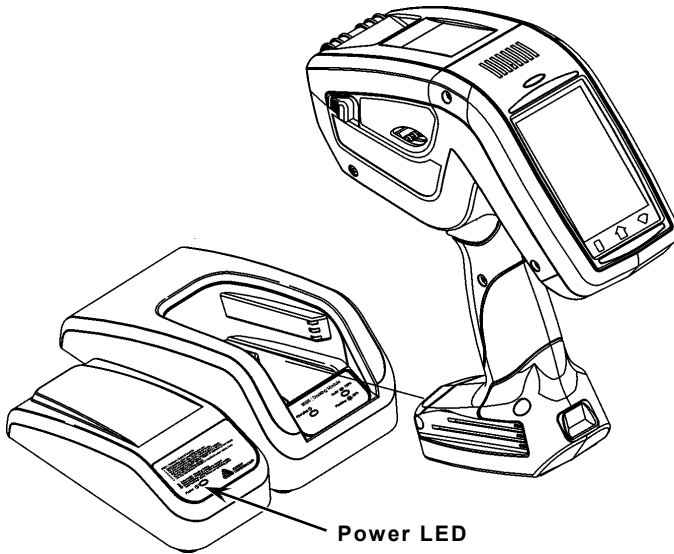

The green power LED on the 6054 Network Control Module turns on when there is power to it.

Charging time can take up to four hours. It takes approximately 2 hours to reach the 80% level (where it is now usable). To reach 100%, it takes approximately 2 hours more.

## Reading the Display

- ◆ Charging LED – flashes when you insert the printer; on (solid) during charging; off when charging is complete.
- ◆ Complete LED – flashes when the printer's battery is 80% charged; on (solid) when the battery is 100% charged.

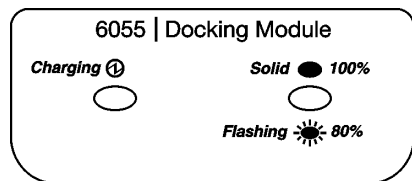

### *Why is the charging status LED blinking again?*

Once the battery reaches 100% charged, it remains at 100% for a period of time before continuously cycling between 80% - 100% charged.

Both LEDs are ON continuously when the docked printer's firmware is updating. **Do not** remove the printer or disconnect power to the Docking Module at this time.

## Using the Printer's LED

---

The Pathfinder® printers have a multicolor LED located above the display. The printer's default settings are:

LED	Status
Red	Printer error
White	Out of supply
Blue	Will not print - low battery

### **When printer is docked (with charger model 6054/6055)**

Blinking green	Network connection
Blinking magenta	No network connection

When the LED is blinking red, the printer is receiving information and should not be turned off, removed from or placed in the docking station.

## Troubleshooting

---

When an error occurs, the Docking Module's Charging and Complete LEDs blink together. In this case, remove the printer, wait for the lights to stop flashing, then re-insert the printer. If the error still occurs, put a new battery into the printer and place the printer back into the charger. If there is a problem after the second attempt to charge, call Service.

# Specifications

---

## **Operating Limits:**

**Temperature** 32°F to 104°F (0°C to 40°C)

**Humidity** 5% to 90% non-condensing

## **Storage Limits:**

**Temperature** -40°F to 158°F (-40°C to 70°C)

**Humidity** 5% to 90% non-condensing

## **One Docking Module**

**Length:** 8.6" (218 mm)

**Width:** 4.75" (121 mm)

**Height:** 3.4" (86 mm)

**Weight:** 1.7 lbs. (0.7 kg)

**Shipping Weight:** 2.2 lbs. (1 kg)

## **Network Control Module**

**Length:** 7" (178 mm)

**Width:** 3.5" (89 mm)

**Height:** 2.25" (57 mm)

**Input:** 12 to 16 VDC/50W

**Weight:** 2.2 lbs. (1 kg)

**Shipping Weight:** 2.7 lbs. (1.2 kg)

## ***Power Supply***

**Input:** Universal switching power supply,  
85 to 264 VAC, 50/60 Hz.

**Output:** 12 VDC/80W max

