



SYSTEM ADMINISTRATOR'S GUIDE



Avery Dennison® Monarch® Tabletop Printer 2

TCADTP2SA Rev. AR 7/24
©2017 Avery Dennison Corp.
All rights reserved.
Classification: Avery Dennison - Public

Each product and program carries a respective written warranty, the only warranty on which the customer can rely. Avery Dennison Corp. reserves the right to make changes in the product, the programs, and their availability at any time and without notice. Although Avery Dennison Corp. has made every effort to provide complete and accurate information in this manual, Avery Dennison Corp. shall not be liable for any omissions or inaccuracies. Any update will be incorporated in a later edition of this manual.

©2017 Avery Dennison Corp. All rights reserved. No part of this publication may be reproduced, transmitted, stored in a retrieval system, or translated into any language in any form by any means, without the prior written permission of Avery Dennison Corp.

Trademarks

Monarch® and MPCL are trademarks of Avery Dennison Retail Information Services LLC.

Avery Dennison® is a trademark of Avery Dennison Corp.

EPCglobal, Inc.™ and Electronic Product Code™ (EPC) are trademarks of GS1/GS1US.



TABLE OF CONTENTS

GETTING STARTED	1-1
Audience	1-1
Using the Control Panel.....	1-1
Display Icons	1-1
Selecting a Function	1-2
Exiting a Function.....	1-2
Printing a Test Label.....	1-2
Removing the Hinged Cover	1-3
SETTING SUPPLY OPTIONS	2-1
Setting the Supply Type	2-2
Setting the Ribbon	2-3
Using a High Energy Ribbon	2-3
Setting the Speed	2-4
Print Speed Considerations with RFID	2-4
Recommended Maximum Print Speeds.....	2-4
Setting the Feed Mode	2-5
Setting the Cut Mode	2-5
Setting the Backfeed	2-5
Adjusting the Position Settings.....	2-6
Setting the Print Position.....	2-6
Setting the Supply Position.....	2-7
Setting the Margin Position.....	2-7
Setting the Cut Position	2-8
Setting the Dispense Position	2-8
Setting the Backfeed Distance	2-8
Using Batch Separators	2-9
Using Skip Index.....	2-9
Setting the Overstrike Mode.....	2-10
Setting the Error Action	2-10
Using Rotate Image	2-11
Setting the Non-Indexed Length	2-11
Setting the Maximum Calibration Length	2-12
Setting the Batch Feed Mode	2-13
Setting the Print Contrast	2-13
SETTING COMMUNICATIONS	3-1
Setting the Baud Rate	3-1
Setting the Word Length	3-2
Setting the Stop Bits	3-2
Setting the Parity.....	3-2
Setting the Flow Control	3-2
Resetting to Default Values	3-3
Using USB Communications.....	3-3
Setting the Mode	3-3

SETTING ETHERNET COMMUNICATIONS	4-1
Viewing the MAC Address.....	4-1
Entering the IP Address.....	4-2
Entering the Subnet Mask.....	4-2
Entering the IP Gateway.....	4-2
Setting the Boot Method.....	4-3
Reset Default Password.....	4-3
Default Network.....	4-3
Factory Defaults.....	4-4
SETTING WIRELESS COMMUNICATIONS.....	5-1
Viewing the Signal Strength.....	5-1
Entering the SSID.....	5-2
Setting the Roam Threshold.....	5-2
SETTING DEFAULTS	6-1
Setting the Language.....	6-2
Setting the Monetary Sign.....	6-3
Setting the Secondary Sign.....	6-3
Setting the Number of Decimal Places.....	6-4
Setting the Slashed Zero Appearance.....	6-4
Setting the Power-Up Mode.....	6-5
Setting the Numeric Format.....	6-5
Using Flash Storage.....	6-5
Setting the Image Error Mode (No Image Error).....	6-6
Setting the Configuration Packet Mode (Ignore Config).....	6-6
Setting the Batch Packet Mode (Ignore BchCtl).....	6-7
Setting the Error Retry Mode.....	6-7
Adjusting the Image Length.....	6-8
Setting the Sleep Delay.....	6-8
Setting the LCD Contrast.....	6-9
Setting the Format Number Mode (Ignore Fmt #s).....	6-9
Using a Temporary Graphics Buffer.....	6-10
Using Flash Memory.....	6-10
Formatting Flash Memory.....	6-11
Viewing Available Flash Memory.....	6-11
Packing Flash Memory.....	6-11
Using a USB Thumb Drive.....	6-12
Updating the RFID Inlay Database.....	6-12
Setting the Clock (Optional).....	6-13
Setting the Hour.....	6-14
Setting the Minute.....	6-14
Setting the Day of the Month.....	6-14
Setting the Month.....	6-14
Setting the Year.....	6-15
Selecting the Interpreter.....	6-15

USING SCRIPTS	7-1
Initial Script Startup Procedures	7-1
Viewing Script Information	7-1
Downloading a Script	7-2
Enabling a Script	7-2
Deleting a Script.....	7-2
Enabling Status Polling	7-3
Using Immediate Commands	7-3
SETTING RFID OPTIONS.....	8-1
About RFID Supplies	8-1
What is Pitch?.....	8-2
Getting Started With RFID	8-3
Using the Auto Calibration Menu	8-3
Successful Auto Calibration.....	8-4
Unsuccessful Auto Calibration	8-4
Failed Auto Calibration.....	8-4
Using the Easy Setup Menu	8-4
Selecting the Inlay.....	8-5
Entering the Inlay Position.....	8-6
Using the Advanced Setup Menu	8-7
Setting Stop-To-Encode Mode.....	8-8
Performance Considerations with RFID	8-8
Enabling Singulate Mode.....	8-9
Setting the Write Power	8-9
Setting the Read Power.....	8-10
Setting the Encode Position.....	8-10
Enabling Tag Saver	8-11
Setting the First TID Position.....	8-11
Setting the Start Encode Position.....	8-12
Setting the Encode Zone	8-13
Verifying the RFID Inlay Data	8-14
Setting the Verify Power.....	8-15
Setting the Tag Verify Position.....	8-15
Enabling Retry Encode.....	8-16
Clearing Data.....	8-16
Using the Read Tag Option	8-16
RFID Troubleshooting with Non-Stop Encoding	8-16
PRINTING	9-1
Downloading Files	9-1
Online Printing	9-2
Offline Printing	9-2
USING DIAGNOSTICS	10-1
Factory Set Password	10-1
Checking the Versions.....	10-2
Checking Supply Quality.....	10-2
Using a Password	10-3

TROUBLESHOOTING	11-1
Configuring a Wireless Printer using a Wired Connection	11-1
Using the Network Console Packet	11-2
Adjusting the Printer to Remove Ribbon Wrinkle	11-4
About the Ribbon's Take-up Reel	11-5
Setting the Supply Guides	11-6
Adjusting the Ribbon Tension	11-7
SPECIFICATIONS & ACCESSORIES	1
Supplies (Media).....	2
String Tags	2
Cable Pinouts.....	2
Accessories	3
Factory-Installed Options.....	3
Shipping the Printer	3
MENU STRUCTURE	1
Supply Menu	2
GLOSSARY	1

GETTING STARTED

The Avery Dennison® Monarch® Tabletop Printer 2 prints on thermal transfer (ribbon) and thermal direct labels or tags. The printer prints labels continuously (in one strip) or on-demand (one label at a time). The printer prints on aperture, die cut, black mark, or continuous (non-indexed) supplies.

This manual also includes basic information for the Avery Dennison® Monarch® EcoCut™ Tabletop Printer 2. For detailed information about the EcoCut printer, refer to the *EcoCut Operating Instructions* on our Web site.

Audience

This manual is for the System Administrator who configures and updates the printer.

- ◆ To load supplies, print labels, or how to care for the printer, refer to the *Operator's Handbook*.
- ◆ To create format and batch packets for printing or how to configure the printer online, refer to the *Packet Reference Manual*.

Monarch® MPCL™ Toolbox Utilities are available on our Web site. However, they are not label production software. Call Customer Service for information about label production software.

Using the Control Panel







The control panel has a four-line LCD display and five buttons. The top three buttons are function buttons, which vary depending on the task shown above the button. The two bottom buttons are navigation buttons. Use these buttons to scroll through menus.

The LCD

- ◆ shows a red background when immediate attention is required for a jam or error.
- ◆ shows a green background when the printer is active (printing or receiving data).
- ◆ shows a white background when viewing menu prompts, printer settings, button functions, etc.

Display Icons

The display icons indicate the following:

Icon	Description	Icon	Description
	RFID successful encode		Wireless mode active
	RFID successful verification		Signal strength
	Battery life		Wired Ethernet mode active
	USB drive installed		

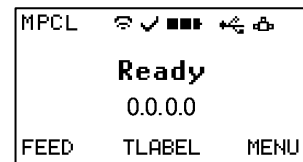
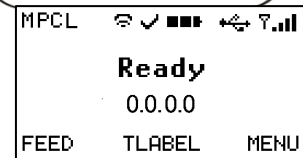
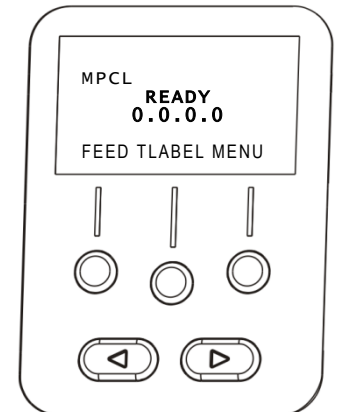

Selecting a Function

Use ← or → to see the menu options. Press **SELECT** when you see the menu option you need. Press **CHANGE** to change a setting. Press **SET** to save a setting.

Exiting a Function

There are two ways to exit an option. Pressing **BACK** once returns to the previous menu and saves any changes. Pressing **CANCEL** exits to the previous menu; however, changes are not saved.

Printing a Test Label

From the Main Menu select **TLABEL**. Select from the test label options:

Printer Information

Contains generic information, including inch counts and printhead resolution.

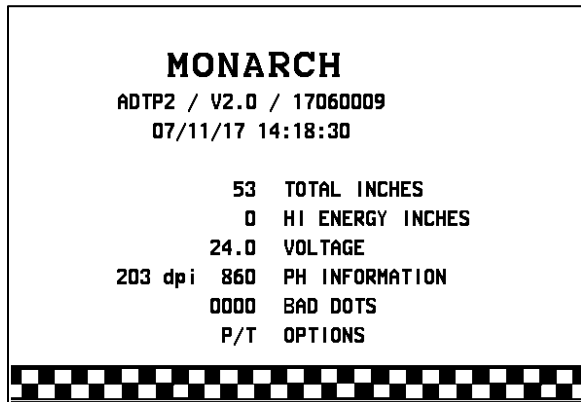

MPCL Label

Contains the printer's MPCL packet configuration.

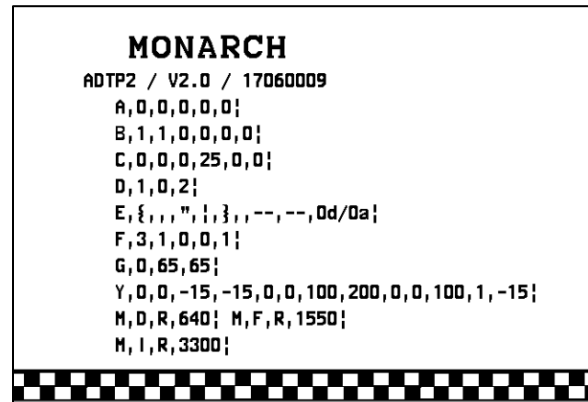

Mnet2 Label

Contains the printer's network/Ethernet configuration.

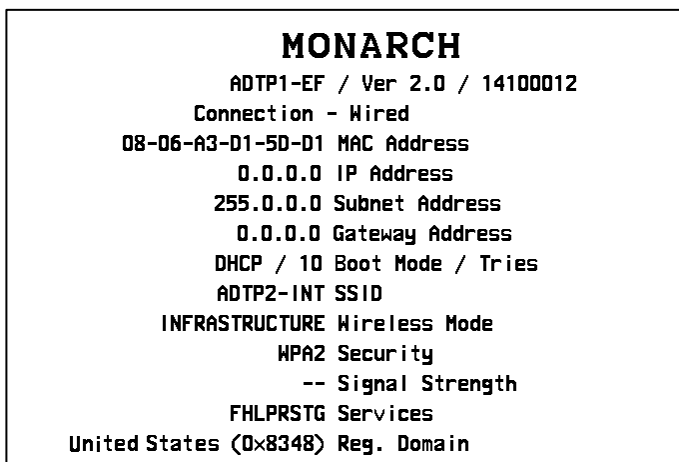

RFID Configuration

Contains the module's Firmware Version, Module Type, Easy Setup Version (RFID Inlay Database), Region, Frequency, etc.

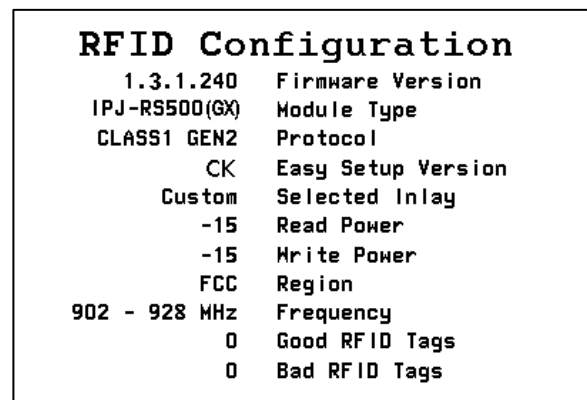

Note: There are two RFID module types: One for FCC (IPJ-RS500GX) and one for ETSI (IPJ-RS500EU) frequency ranges.

Removing the Hinged Cover

1. Open the cover.
2. Unlock the printhead by turning the retaining latch.
3. Lift the printhead assembly using the printhead tab until the assembly locks into place.
4. Remove both cover thumbscrews.
5. Gently push down on the control panel release tab located inside the front cover. The control panel tilts forward.

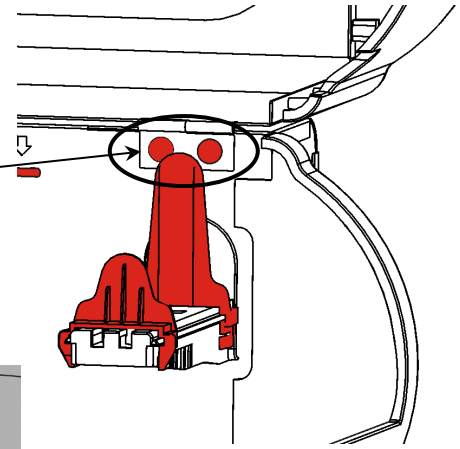

Control Panel

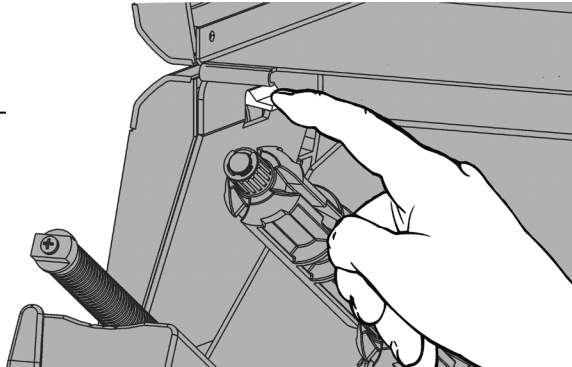

6. Using both hands, slide the cover to the left and remove.

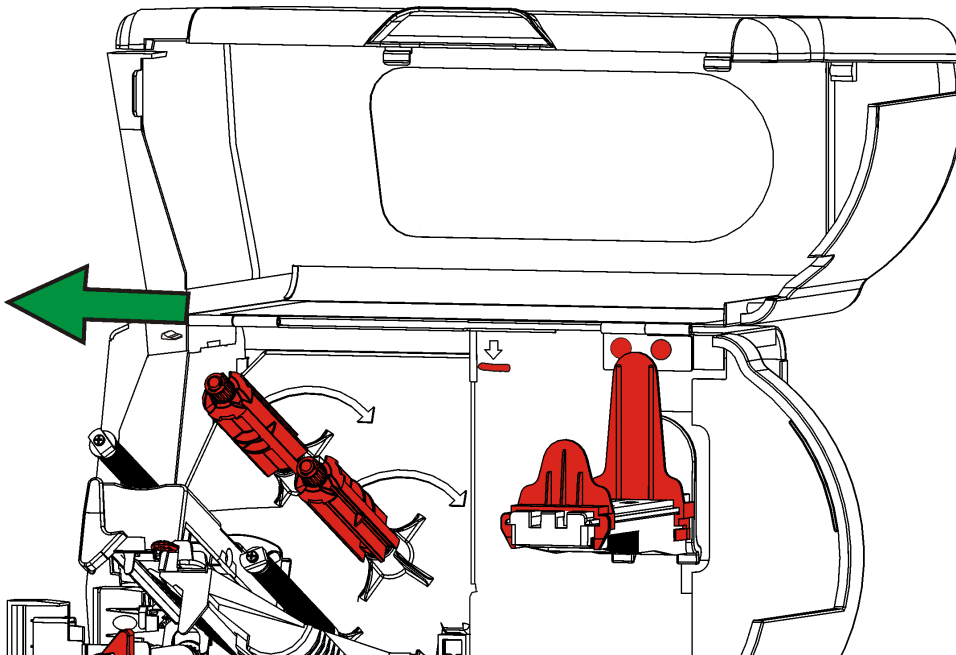

SETTING SUPPLY OPTIONS

This chapter explains how to select the supply type, ribbon, speed, feed mode, cut mode, backfeed, print position, supply position, margin position, cut position, dispense position, backfeed distance, separators, skip index mode, rotate image, non-indexed length, maximum calibration length, batch feed mode, and print contrast.

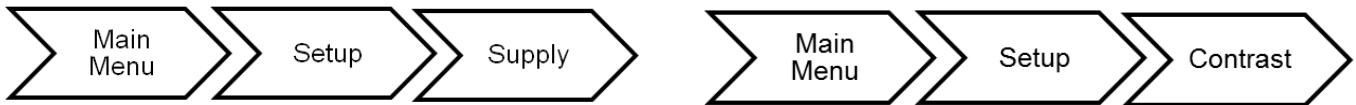

You may limit access to this menu to prevent changes by the users. Users are prompted to enter a password when password protection is enabled.

<p>Enter password: ***** FEED ENTER CANCEL</p>

The supply options are listed in the table below.

Option	Choices	Default
Supply Type	E Aperture/E Die Cut/E Black Mark/Continuous/ C Aperture/C Die Cut/C Black Mark/C Tag Edge	E Die Cut
Ribbon	No/Yes/High Energy	Yes
Speed	2.5/4.0/6.0/8.0/Default	Default
Feed Mode	Continuous/On-Demand/Liner Takeup	Continuous
Cut Mode	Disabled/Cut Each Tag/Cut Each Batch	Disabled
Backfeed	Off/On	Off
Print Position	-450 to 450	0
Supply Position	-300 to 300	0
Margin Position	-99 to 99	0
Cut Position	-300 to 300	0
Dispense Position	50 to 200	65
Backfeed Distance	10 to 200	65
Separators	No/Yes/Long	No
Skip Index	No/Yes	No
Overstrike Mode	Standard/Minimal	Standard
Error Action	Normal Overstrike/Continue 1x – 5x	Normal
Rotate Image	No/Yes	No
Non Indexed Length	0 (value is not set) 1218 to 3248 in 203 dpi (6.0" to 16.0") 1800 to 4800 in 300 dpi (6.0" to 16.0")	1218 (203 dpi) 1800 (300 dpi) or last format length
Maximum Calibration Length	0 to 6902 (203 dpi = 34 inches)	3552
Batch Feed	Automatic/Manual	Automatic
Contrast	-699 to 699	0

Press **CANCEL** to exit an option without changing the setting.

Setting the Supply Type

The printer can print on aperture, black mark, die cut, or continuous supplies as shown. Set the printer's supply type to match the loaded supplies.

Supply/print position adjustments and the format determine where the printing begins on the supply.

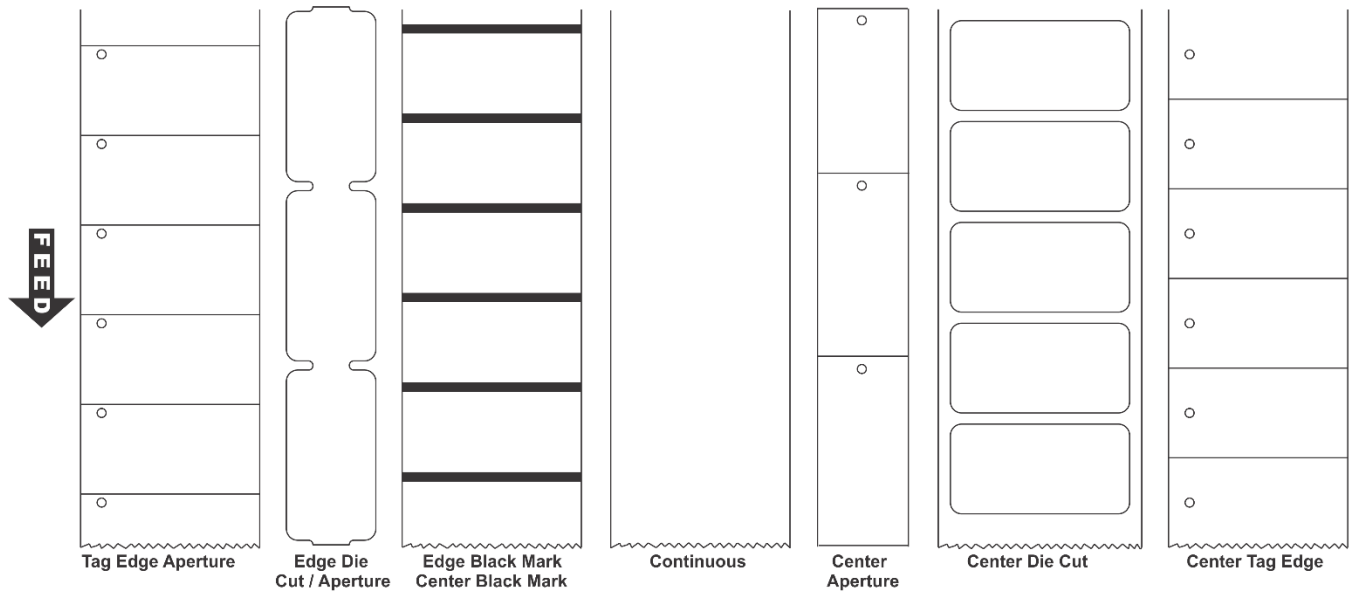

Select

E Aperture
(Tag Edge Aperture)

E Die Cut (Edge Die Cut) or
C Die Cut (Center Die Cut)

E Black Mark (Edge Black Mark)
or
C Black Mark (Center Black Mark)

Continuous

For

Aperture holes (or openings) on the left edge of the supply. The supply is sensed using the holes. You may need to make supply or print position adjustments on your format. See description for Center Tag Edge.

Die cut supplies have a rounded edge. The supply is sensed using the gap between the labels. If using semi die cut supplies (tags with rounded corners on the edges), select Edge Die Cut.

Black marks on the back of the supply for sensing. The supply is sensed using the black mark. Select E Black Mark for black marks on the left edge. Select C Black Mark for black marks in the center. Select C Black Mark for black marks across the entire width of supply.

Continuous supply does not have any index marks for sensing or perforations. This is also known as non-indexed supply. **This is the default for Avery Dennison® Monarch® EcoCut™ printers.** EcoCut printers feed 1.5 inches of supply when calibrating or whenever **Feed** is pressed.

C Aperture (Center Aperture)	Aperture holes (or openings) in the center of the supply. They do not contain a black mark. The supply is sensed using the holes.
Center Tag Edge	Center tag edge supply has aperture holes (or openings) centered on the left edge of the supply. The supply is sensed using the holes. Using this setting, the printer automatically calibrates to print at the leading edge. No additional supply/print position adjustments are necessary.

Setting the Ribbon

There are different ribbon requirements for the types of supplies:

Select	To
No (for thermal direct supply)	Not use a ribbon for printing.
Yes (for thermal transfer supply)	Require a ribbon for printing.
Hi Energy (High Energy Supply - TUFF-MARK®)	Require an elevated heat setting for resin ribbon applications.



Using a High Energy Ribbon

When you select high energy ribbon for the printer setting, you are setting the printer to a higher printing temperature. Select this setting only after you have loaded a high energy ribbon and supplies or it may damage the printhead.

High Energy Ribbon Limitations:

- ◆ Use a print speed of 2.5 ips.
- ◆ Serial bar codes cannot be printed.
- ◆ Reverse fonts cannot be used.
- ◆ Do not print horizontal lines or bars.
- ◆ Requires a non-printing area at least 0.1 inch (2.54 mm) on left and right edge of ribbon.
- ◆ No more than 20% of the supply should have print (black coverage).
- ◆ Printhead warranty is reduced to 100,000 inches.
- ◆ Do not use peel mode
- ◆ Not for use on full tinted supplies.
- ◆ Graphics are limited.

CAUTION: The high energy ribbon may break or stick to the supply when more than 20% of the supply contains print.

Setting the Speed

Select the print speed in IPS (inches per second). If print quality is important, reduce the print speed - a lower print speed increases the print quality of labels. Use premium supplies when printing at high speeds.

Select	To
2.5 IPS	Print at 2.5 IPS.
4.0 IPS	Print at 4.0 IPS.
6.0 IPS	Print at 6.0 IPS.
8.0 IPS	Print at 8.0 IPS.
Default	Print formats with serial bar codes at 2.5 inches per second and formats with parallel bar codes at 6.0 inches per second.

Print Speed Considerations with RFID

The RFID settings in Easy Setup (and the RFID Printer Setup Utility) are based on encoding 96-bits of EPC data with a lock code. If your RFID data is more complex than 96-bits of EPC data with a lock code, you may need to decrease the printer's speed in non-stop encode mode. The following examples may require a decreased print speed:

- ◆ encoding 96-bits of EPC data and programming user memory
- ◆ encoding more than 96-bits of EPC data with a lock code
- ◆ encoding more than 96-bits of EPC data and programming user memory

When using Easy Setup to configure the printer for RFID supplies, the print speed *may be decreased*. For example, some inlays encode better at slower speeds, so if the printer is set for 8.0 ips, Easy Setup may change the print speed to use 4.0 ips instead.

The amount of programmable EPC data, user memory, access password, and lock code data varies by print speed and RFID chip. If the printer cannot program all the RFID data within the allotted time, an error occurs.

Recommended Maximum Print Speeds

Options:	Print Speed, inches per second	
	2.5/4.0/6.0	8.0
300 dpi printhead	supported	supported
Tags	supported	supported
TuffMark® Supply	2.5 ips max. recommended	not recommended
Serial bar codes	2.5 ips max. recommended	not recommended
Liner Take-up	supported	supported
Cutter	supported	supported
Cutter with Catch Tray	supported	not recommended
Peel Mode	supported	supported

Note: If you change the speed, you must resend your formats or turn off the printer and back on before the change takes effect. If you change the speed *in offline mode*, turn off the printer then turn it back on before the change takes effect. Refer to the *Cutter's Operating Instructions* for more information about the cutter.

Setting the Feed Mode

Set the feed mode based on your application and supply type. To load supplies for liner take-up, refer to the *Operator's Handbook*. To load supplies for the EcoCut printer, refer to the *EcoCut Operating Instructions* on our Web site.

Select	To
Continuous	Print tags or labels in one strip.
On-Demand	Print one label, once that label is removed, the next label prints. This is the default for Avery Dennison® Monarch® EcoCut™ printers.
Liner Take-up	Print labels while the liner is collected on a take-up reel inside the printer. This is optional.

Setting the Cut Mode

Set how the printer cuts tags. You must purchase the ADTP2 cutter model, which has a stop-to-cut cutter.

Select	To
Disabled	Does not cut.
Cut each tag	Cuts after each tag in the batch. This is the default for Avery Dennison® Monarch® EcoCut™ printers.
Cut each batch	Cuts after the <i>last</i> tag in the batch (cuts in strips) not each tag. We do not recommend this mode with EcoCut printers.

Refer to the *Cutter's Operating Instructions* or the *EcoCut Operating Instructions* for more information.

Setting the Backfeed

Backfeed advances each printed label to the desired dispense position. Once that label is removed, the next label to be printed is backed up underneath the printhead.

Select	To
Off	Disable backfeed.
On	Enable backfeed. The printer moves the supply backwards before printing. Use the Positioning menu to set the dispense position and the backfeed distance.

Adjusting the Position Settings

This menu includes selections to change the print, supply, margin, cut, dispense, and backfeed distance positions.



See the following graphic for a representation of the following adjustments: dispense position, backfeed distance, supply position, print position, and margin position.

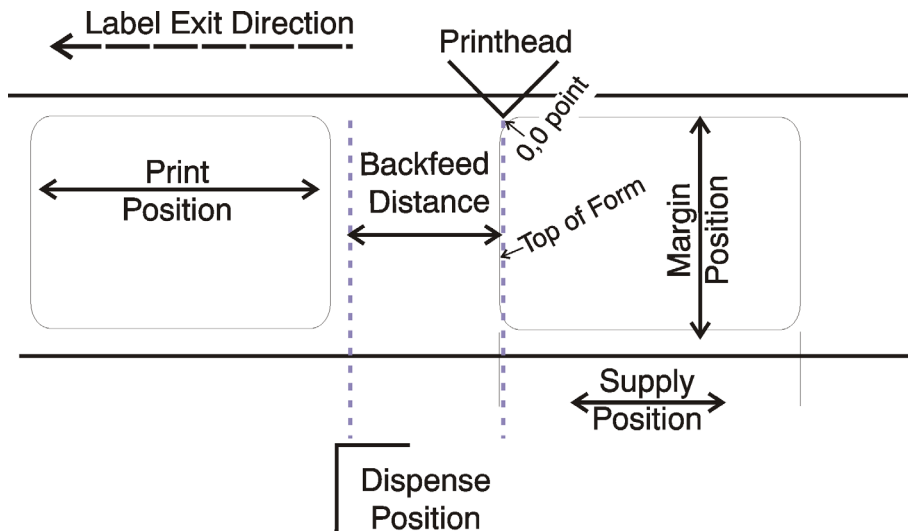

Setting the Print Position

This function adjusts the image's position on the supply in the feed direction. Adjust the print position if the print is too close to the top or bottom of the supply, or overtypes the pre-printed area. The adjustments are in dots where one dot equals 0.0049 inch.

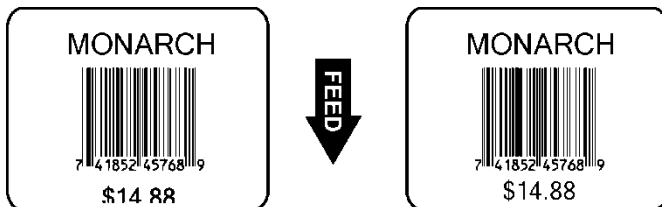

Changing this setting only affects new formats sent to the printer. Any formats previously saved into flash memory are not affected.

- | Select | To |
|--------|---|
| ← | Decrease the setting. Moves the print down. |
| → | Increase the setting. Moves the print up. |

Press **1** to toggle the amount (1, 10, or 100).

Setting the Supply Position

This function adjusts the position of the supply relative to the index marks in the feed direction. Adjust the supply position to compensate for supply variation. The adjustments are in dots where one dot equals 0.0049 inch.

Adjust the supply position only on initial printer setup. For format adjustments, change the print position. This option takes effect when you print the next label or tag. Changing supply position may also affect print position.

Select	To
←	Decrease the setting. Moves the print down.
→	Increase the setting. Moves the print up.

Press **1** to toggle the amount (1, 10, or 100).

Setting the Margin Position

This function adjusts where the format prints side to side on the supply. The adjustments are in dots where one dot equals 0.0049 inch.

The width of the print area depends on the supply size. The maximum width is four inches. When you move the image to the right or left on the supply, avoid moving the image too close to either edge, because it may not print.

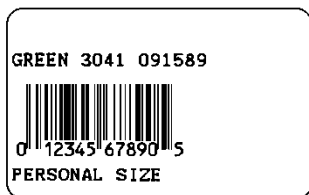

Print too far to the left

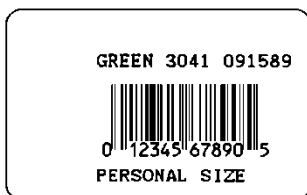

Print too far to the right

Changing this setting only affects new formats sent to the printer. Any formats previously saved into flash memory are not affected.

Select	To
←	Decrease the setting. Moves print to the left.
→	Increase the setting. Moves print to the right.

Press **1** to toggle the amount (1, 10, or 100).

Setting the Cut Position

This function adjusts where the tag is cut. The printer adjusts the cut position according to the index marks on the supply. Aperture supplies may need adjustments. Increase to move the cut up; decrease to move the cut down.

Select	To
←	Decrease the setting. Moves the cut down.
→	Increase the setting. Moves the cut up.

Press **1** to toggle the amount (1, 10, or 100).

Setting the Dispense Position

This function adjusts the amount to advance each label to allow for easy removal from the printer.

Select	To
←	Decrease the setting. Moves the print down.
→	Increase the setting. Moves the print up.

Press **1** to toggle the amount (1, 10, or 100).

Setting the Backfeed Distance

The function adjusts the amount to move the label backwards at the start of each batch (or label in on-demand mode). The backfeed distance should be equal to or less than the dispense position. If the backfeed distance is greater than the dispense position, the dispense position automatically changes to match the backfeed distance.

Select	To
←	Decrease the setting. Moves the print down.
→	Increase the setting. Moves the print up.

Press **1** to toggle the amount (1, 10, or 100).

Note: When tearing butt cut supplies, the backfeed distance must be 30 dots (0.15 inches) less than the dispense position. This causes a 30-dot non-print zone on the supply, but prevents exposed adhesive under the printhead.

Using Batch Separators

A batch separator is an extra tag printed in between batches with a pinstripe pattern. For continuous supply, the batch separator is always six inches long. The batch's name prints on the batch separator.

Changing this setting only affects new formats sent to the printer. Any formats previously saved into flash memory are not affected.

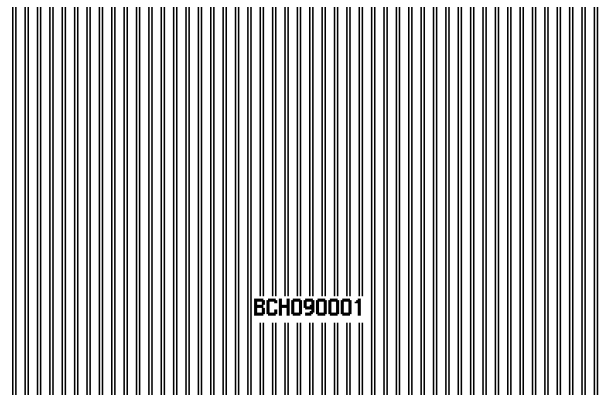

Batch Separator

Select	To
No	Disable batch separators. Do not use batch separators with continuous (non-indexed) supply.
Yes	Enable batch separators.
Long	Enable double-length (two tags) batch separators.

Using Skip Index

Skip index mode skips (or ignores) a sense mark and prints an image over multiple labels, if necessary. For example, if you have 4.0" long supplies loaded, but the image is 8.0" long, enable skip index mode to print the 8.0" long image on two labels. Use the skip index feature when you have a **single** format that contains two labels, such as a shelf label and a carton label.

The image length is determined by the format header. Refer to the *Packet Reference Manual* for more information.

When designing the format, make sure text or graphics do not print in the gap of label rolls. Do not use skip index with RFID supplies.

Select	To
No	Disable skip index.
Yes	Enable skip index and print a format on two (multiple) labels.

Setting the Overstrike Mode

Sets the overstrike when the printer senses a bad RFID inlay. Selecting standard prints the standard overstrike pattern. Selecting minimal prints a lighter overstrike pattern allowing the label to remain human readable, but indicates the label was **not** successfully encoded.

When using Minimal Overstrike, bad RFID inlays/labels are printed regardless of other printer settings. For example, if you send a batch of ten labels and one has a bad RFID inlay, minimal overstrike will print one overstrike and nine successfully printed and encoded labels while standard overstrike will print one overstrike and ten successfully printed and encoded labels.

Note: Minimal Overstrike cannot be used with Option 5 (refer to the ADTP1 Packet Reference Manual).

Select	To
Standard	Use standard overstrike mode.
Minimal	Use minimal overstrike mode.



Sample Minimal Overstrike

Setting the Error Action

Sets how the printer recovers/responds to a bad RFID inlay. Selecting overstrike and continue 1x-5x sets the number of times the printer prints an overstrike pattern on consecutively bad labels before generating an error. The user must clear the error before operation can continue. The overstrike pattern prevents someone from using a bad label.

Note: Do not use the overstrike action with peel mode.

Select	To
Normal	Display the error. The error must be cleared before operation can continue. Press CANCEL to clear the error and continue printing. No overstrike pattern is printed.
Overstrike/Continue 1x	Attempt to reprint the label for one, two, three, four, or five consecutive tries. An overstrike pattern is printed each time the reprint fails. Printing is stopped after the selected number of overstrike patterns have printed. Press CANCEL to clear the error and continue printing. Do not use the overstrike label.
Overstrike/Continue 2x	
Overstrike/Continue 3x	
Overstrike/Continue 4x	
Overstrike/Continue 5x	

Example: Error action is set to overstrike/continue 3x:

If the printer errors on the first label, an overstrike pattern is printed, but the printer attempts to reprint the image up to three times. If the third consecutive label also generates an error, an overstrike pattern is printed; however, the printer stops and the error message is displayed. The operator must resolve the error condition before printing continues.

In the above example, if the third label did NOT generate an error,

- ◆ the batch image is printed
- ◆ the consecutive error counter is reset
- ◆ the printer continues processing the batch.

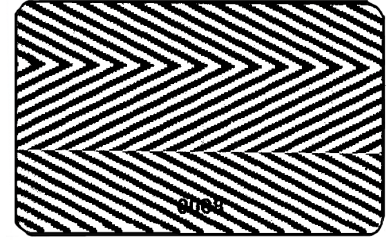

Sample Overstrike Label

Using Rotate Image

Enabling this option rotates the printed image 180°. This is useful when the orientation of the supply does not match the format.

We recommend designing your formats as needed, so image rotation is not required. Make sure the loaded supply matches the image length and width or the rotated image does not print correctly.

Select	To
No	Print the image without rotation.
Yes	Rotate the image 180° before printing.

Setting the Non-Indexed Length

This setting is only valid on Avery Dennison® Monarch® EcoCut™ printers.

EcoCut supply is cut based on the feed length in the format header's *length* parameter. See "Defining the Format Header" in the *Packet Reference Manual* for more information. Using 0 for the non-indexed length indicates the length comes from the format header.

To override the setting in the format header, specify the non-indexed length in dots. The default is six inches. The range is 1218 to 3248 in 203 dpi (6.0" to 16.0") or 1800 to 4800 in 300 dpi (6.0" to 16.0").

Select	To
←	Decrease the setting. Shortens the feed length.
→	Increase the setting. Increases the feed length.

Press **1** to toggle the amount (1, 10, or 100).

Setting the Maximum Calibration Length

When using supply longer than 17.0 inches (3451 dots; 17 inches x 203 dots per inch = 3451 dots), set the maximum calibration length value to properly calibrate your supply. The maximum calibration length is 34.0 inches (6902 dots).

Dots = Inches x 203

Dots = Metric (1/10 mm) x .799

Metric (1/10 mm) = inches x 254.

Determine the maximum calibration length. Measure the supply according to the supply type.

Die cut supplies Measure from the leading edge of one label to the leading edge of the next label accounting for the die cut gap. Enter this value in dots.

Black mark supplies Measure from the top of one black mark to the top of the next black mark. Enter this value in dots.

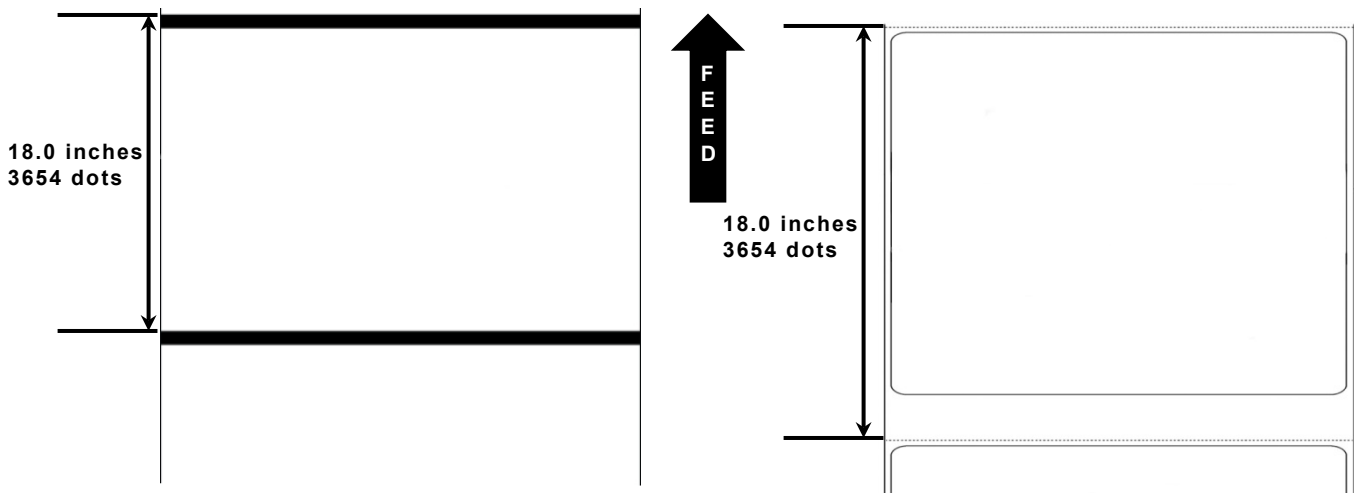

The leading edge is the edge of the label that exits the printer first; regardless of how the format is designed on the label.

Select **To**



Decrease the setting. Shortens the maximum calibration length.



Increase the setting. Increases the maximum calibration length.

Press **1** to toggle the amount (1, 10, or 100).

Setting the Batch Feed Mode

This setting is only valid on Avery Dennison® Monarch® EcoCut™ printers.

Batch feed mode sets the operation of printed batches as automatic or manual on EcoCut printers using continuous feed mode and cutting each tag.

Select	To
Auto	Batch feed mode feeds and cuts a blank label after batches finish printing for easy removal. This is the default setting. If multiple batches are sent at once, a blank label feeds <i>only after the last batch prints</i> . If batches are sent one at time, a blank label feeds after <i>each</i> batch.
Manual	The user must press Feed to manually advance the printed and cut batch for easy removal. Recommended for 1.2-inch long cut lengths.

Setting the Print Contrast

The contrast controls the darkness of the printing. Having the correct print contrast setting is important because it affects how well your bar codes scan and how long your printhead lasts. High contrast settings may require additional printhead cleaning, create bar code growth, and/or lead to reduced scanning.

Solid black print cannot exceed 30% of any given square inch of the supply.

Select	To
←	Decrease the contrast. Lightens the print.
→	Increase the setting. Darkens the print.

Press **1** to toggle the amount (1, 10, or 100).

We recommend you check the bar code print quality. A bar code that is in spec has complete bars, clear spaces, and small alphanumeric characters look complete. An in spec bar code may not look as good as one that is too dark, but it has the highest scan rate.



SETTING COMMUNICATIONS

This chapter tells you how to set the serial and USB communication values. These values provide the link for normal online printing.

You need to set your Serial Comm values to match your computer's online communications.

The serial communication values are in the table below.



Option	Choices	Default
Baud rate	1200/2400/4800/9600/19200/38400/57600/115200	9600
Word length	7/8	8
Stop bits	1/2	1
Parity	None/Odd/Even	None
Flow control	None/Xon/Xoff/DTR/CTS	DTR
Reset	No/Yes	No

The serial values on the printer must match those at the host.

Setting the Baud Rate

Baud rate is the speed, in bits per second, at which the printer sends and receives data.

Select	To
1200	Communicate at 1200 bits per second.
2400	Communicate at 2400 bits per second.
4800	Communicate at 4800 bits per second.
9600	Communicate at 9600 bits per second.
19200	Communicate at 19200 bits per second.
38400	Communicate at 38400 bits per second.
57600	Communicate at 57600 bits per second.
115200	Communicate at 115200 bits per second.

Setting the Word Length

Word length specifies the number of data bits the printer uses to define a character.

Select	To
7	Set the word length to seven.
8	Set the word length to eight.

Setting the Stop Bits

A stop bit follows the data and parity bits to signal the end of a character.

Select	To
1	Set the stop bit length to one.
2	Set the stop bit length to two.

Setting the Parity

Parity checks the validity of data entering the printer. The parity bit immediately follows the last data bit for a character. The computer adjusts the parity bit according to the parity so the data bits in the character, with the parity bit, form an odd or even number when summed.

Select	To
None	Set the parity to none (no parity check).
Odd	Set the parity to odd.
Even	Set the parity to even.

Setting the Flow Control

Data flow control is the method the printer uses to tell the computer whether it is ready to accept data.

Select	To
None	Set the flow control to none.
Xon/Xoff	Set the flow control to XON/XOFF. XON is 17; XOFF is 19.
DTR	Set flow control to DTR (Data Terminal Ready). This is the most common setting. Use it for PC computers (unless you have XON/XOFF software).
CTS	Set flow control to CTS (Clear to Send).

Resetting to Default Values

Use this setting to reset the printer's communication values to the defaults listed at the beginning of this chapter.

Select	To
No	Do not reset the serial communication values to their defaults.
Yes	Reset the serial communication values to their defaults.

Using USB Communications

Set the mode for the USB port. *The printer reboots whenever the USB mode is changed.*



The USB settings are in the table below.

Option	Choices	Default
Mode	Printer/Virtual Serial	Printer

Setting the Mode

Select	To
Printer	Using the Printer port, Microsoft® Windows® prompts the user for the printer driver, which is provided by our third-party developers and found on our Web site:

<https://printers.averydennison.com/en/home/resources/service-and-support/utilities-and-firmware/ADTP2-printer.html>

Download the latest drivers and follow the on-screen prompts as necessary.

Virtual Serial	Using the Virtual Serial port requires the ADTPx.inf file, which installs the printer as a virtual com port (for example COM4, COM5, etc.) and can be found on our Web site:
----------------	---

<https://printers.averydennison.com/en/home/resources/service-and-support/utilities-and-firmware/ADTP2-printer.html>

Download the latest drivers and follow the on-screen prompts as necessary.

The updated driver appears in the Ports list. When connected via USB, the printer's display includes the USB status icon:

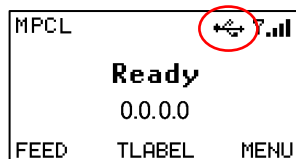

SETTING ETHERNET COMMUNICATIONS

4

The printer communicates on a 10baseT or 100baseTX wired Ethernet connection or on an 802.11 a/b/g/n network. See Chapter 5, "[Setting Wireless Communications](#)" for more information.



The printer's display shows the  network symbol (wired) when the printer is connected and ready to receive data. Additionally, the printer's IP address is displayed when a connection is established.

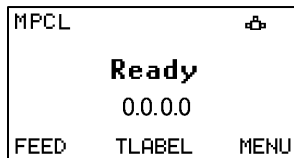

The network options are listed in the table below.

Option	Choices	Default
MAC Address	View only	None – preset value
IP Address	xxx.xxx.xxx.xxx	0.0.0.0
Subnet Mask	xxx.xxx.xxx.xxx	0.0.0.0
IP Gateway	xxx.xxx.xxx.xxx	0.0.0.0
Boot Method	Static/DHCP	Auto
Wireless	See Chapter 5, " Setting Wireless Communications ."	N/A
Reset Default Password	No/Yes	N/A
Default Network	Default Setting/Factory Default	N/A

Viewing the MAC Address

The Media Access Control (MAC) Address is a hard-coded value that cannot be changed (like a serial number). It consists of four 3-digit numeric fields, usually separated by periods.

Select To

MAC Address View the printer's MAC Address.

With version 1.6 or greater firmware, the Ethernet and wireless interfaces share the same MAC Address. When using DHCP, Ethernet and wireless will receive the same IP address from a DHCP server.

Entering the IP Address

The IP (Internet Protocol) address is a unique identifier for a device on a network. It consists of four 3-digit numeric fields, separated by periods. The printer has different IP addresses for wired vs. wireless communication.

If using the optional keyboard, enter the IP address you need using the numeric keys and press **ENTER**.

Select	To
IP Address	Change the printer's IP address. Press ← or → to highlight the position to change. Press CHANGE until you see the number you need. Press SET to save the setting or press CANCEL to exit without saving.

If you enter a series of digits greater than 255 for any segment of the IP address and press **SET**, the printer does not save the setting. Correct the setting, then press **SET**.

Entering the Subnet Mask

IP networks are divided using subnet masks. The subnet mask address determines where the IP address belongs in the network. It consists of four 3-digit numeric fields.

If using the optional keyboard, enter the subnet mask you need using the numeric keys and press **ENTER**.

Select	To
Subnet Mask	Change the printer's subnet mask. Press ← or → to highlight the position to change. Press CHANGE until you see the number you need. Press SET to save the setting or press CANCEL to exit without saving.

If you enter a series of digits greater than 255 for any segment of the IP address and press **SET**, the printer does not save the setting. Correct the setting, then press **SET**.

Entering the IP Gateway

The IP gateway (or router) allows connections (communications) between different subnets on a network. It consists of four 3-digit numeric fields.

If using the optional keyboard, enter the IP gateway you need using the numeric keys and press **ENTER**.

Select	To
IP Gateway	Change the printer's IP gateway. Press ← or → to highlight the position to change. Press CHANGE until you see the number you need. Press SET to save the setting or press CANCEL to exit without saving.

If you enter a series of digits greater than 255 for any segment of the IP address and press **SET**, the printer does not save the setting. Correct the setting, then press **SET**.

Setting the Boot Method

The boot method sets the way the device receives its IP address.

Select	To
Static	Use if your network uses fixed configuration. The IP address remains the same every time the device connects to the network.
DHCP	The network automatically assigns an IP address within a specified range to a device when it is first turned on. A device could have a different IP address every time it connects to the network. Note: If no IP address appears on your printer, it indicates the DHCP request failed.

Reset Default Password

Reset the password for Web browser and Telnet sessions to the default **access** (using version 3.0 or greater firmware). The password is reset and the printer restarts. Make a note of the password if you change it.

Default Network

The default network option allows you to reset the Ethernet/wireless module.

Select	To
Default Setting	Any defaults set using the SET DEFAULT Telnet console command are restored.
Factory Default	Reset the module to factory defaults. See " Factory Defaults " for the list of default values. When the module is reset to factory defaults, you must reconfigure all your specific network settings, including IP address, SSID, etc.

Depending on your printer's boot method, the IP address may be automatically assigned when you turn on the printer. The new IP address may not be the same as the previous one.

Factory Defaults

If you reset the Ethernet/Wireless module to factory defaults, the following values are restored. **Some settings may stay the same, depending on your network configuration.**

Description	Default
MAC Address	This value is hard-coded and does not change
IP Address	*
Subnet Mask	*
IP Gateway	*
Signal Strength	0
SSID	<none>
Wireless Mode	Infrastructure
Roam Threshold	6
Boot Method	DHCP
TCP Port	9100
Name	PXR_XXXXXX (XXXXXX = last six digits of the MAC address.)
Encryption Mode	Disabled
Authentication Type	Open System
Regulatory Domain	United States



* May keep previous values based on network configuration.

SETTING WIRELESS COMMUNICATIONS

Using the Wireless Menu, you can view the signal strength, set the Service Set Identifier (SSID), wireless mode, roam threshold, transmit rate, and channel.



All nodes of a wireless network need to have the same settings to communicate with each other. If the printer is not communicating with the wireless module, the Network Menu options do not appear.

The printer’s display shows the  network symbol (wired) or the  antenna symbol (wireless) when the printer is connected and ready to receive data. Additionally, the printer’s IP address is displayed when a connection is established.

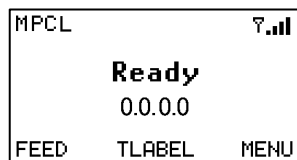

To configure the printer using MonarchNet2™, refer to the *MonarchNet2 Operating Instructions* on our Web site.

With version 1.6 or greater firmware, the Ethernet and wireless interfaces share the same MAC Address. When using DHCP, Ethernet and wireless will receive the same IP address from a DHCP server.

The options are listed in the table below.

Option	Choices
Signal Strength	0 to 100
SSID	XXXXXXXXXXXXXXXXXX
Roam Threshold	1 to 15

Viewing the Signal Strength

The connection between the device and access point is shown as signal strength, which is a percentage from 0 to 100, where 0 is no connection and 100 is an excellent connection.

- A percentage below 50 means printing performance could be affected.
- A percentage below 30 indicates you may be experiencing interference or are close to being out of the access point’s range.

To improve the signal strength, try moving the printer closer to the access point and away from other radio devices such as Bluetooth® wireless devices, microwave ovens, or 2.4-gigahertz cordless phones.

Entering the SSID

The Service Set Identifier (SSID) is a unique identifier that must match for all nodes on a sub network to communicate with each other. It consists of up to 32 characters (any printable character, including spaces). If using the space character, it must be enclosed in quotation marks.

The SSID is case-sensitive. If using the optional keyboard, enter the SSID you need using the numeric keys and press **Enter**.

Select	To
SSID	<p>Change the printer's SSID.</p> <p>To highlight the position to change, press ← or → until the cursor is below the character to change.</p> <p>Press CHANGE until the character you need appears.</p> <p>Press SET to save each position. The cursor moves to the next position. Press SET when finished or press CANCEL to exit without saving.</p> <p>Hold CHANGE to scroll quickly through the characters or press CHANGE once to scroll one character at a time.</p> <p>To clear the SSID, scroll to the end of the field, press and hold ← and → at the same time for a few seconds, then release. If you are in the middle of the field, press and hold ← and → at the same time for a few seconds, then release, to clear any characters to the right of the cursor.</p>

Setting the Roam Threshold

Sets the roaming threshold. Whenever the printer's signal strength gets below this value, the printer connects to another access point in range with better signal strength. This prevents excessive roaming between access points if the printer is located near two access points.

The range is 1-15. 1 gives no preference to the currently connected access point. 15 gives the maximum preference to the currently connected access point.

Select	To
1 - 3	Sets the roam threshold to 11 decibels. When the printer's signal strength gets below 11 decibels, it connects to another access point in range with better signal strength.
4 - 6	Sets the roam threshold to 12 decibels.
7 - 10	Sets the roam threshold to 13 decibels.
11 - 13	Sets the roam threshold to 14 decibels.
14 - 15	Sets the roam threshold to 15 decibels.

This setting is helpful when the printer is on a Mobile Workstation.

SETTING DEFAULTS

6

This chapter explains how to select the printer's prompt language; monetary sign, secondary sign, decimal places, slashed zero, power-up mode, imaging errors, ignore configuration packets, error retry, adjust the image length, set the sleep delay, set the LCD contrast, ignore format numbers, and use a temporary graphics buffer.

This chapter also explains how to format flash, check the available flash memory, and pack flash memory.



You can set your printer configurations to fit your daily operation, using either the offline menus or the online configuration option. After an option is selected in the online configuration or offline Setup Menu, the option is saved when the printer is turned off.

The monetary formatting options are in the table below.

Option	Choices	Default
Language	English, Français, Deutsch, Español-ES, 日本語, Português, Italiano, Svenska, Español-MX, Dansk, Nederlands, Polski, Türkçe, 简体中文, Français-CA	English
Monetary sign	None, \$ Dollar, £ Pound, ¥ Yen, ₰ Deutsche Mark, F Franc, P Peseta, L Lira, Kr Krona, ¢ Markka, ₧ Shilling, Rs Rupee, ₴ Ruble/Rubel, ₩ Won, ฿ Baht, ¥ Yuan, € Euro	\$ Dollar
Secondary Sign	No/Yes	No
Decimal Places	0/1/2/3	2
Slashed Zero	No/Yes	No
Powerup Mode	Online/Offline	Online
Numeric Format	Default, Arabic-Indic, Eastern Arabic	Default
Flash Storage	Disabled/Enabled	Disabled
No Image Error	Disable/Enable	Disable
Ignore Config	Disable/Enable	Disable
Ignore BchCtl	Disable/Enable	Disable
Error Retry	Disable/Enable	Enable
Adjust Length	-30 to 30	0
Sleep Delay	0 to 240	60
LCD Contrast	1 to 9	3
Ignore Fmt #s	Disable/Enable	Disable
Temp G. Buffer	Disable/Enable	Disable

Setting the Language

The printer can display prompts in different languages: English, Français, Deutsch, Español-ES, 日本語, Português, Italiano, Svenska, Español-MX, Dansk, Nederlands, Polski, Türkçe, 简体中文, and Français-CA.

Some prompts may remain in English, even if you select a different language.

Select	To
English	Displays prompts in English.
Français	Displays prompts in French.
Deutsch	Displays prompts in German.
Español-ES	Displays prompts in European Spanish.
日本語	Displays prompts in Japanese.
Português	Displays prompts in Portuguese.
Italiano	Displays prompts in Italian.
Svenska	Displays prompts in Swedish.
Español-MX	Displays prompts in Latin American Spanish.
Dansk	Displays prompts in Danish.
Nederlands	Displays prompts in Dutch.
Polski	Displays prompts in Polish.
Türkçe	Displays prompts in Turkish.
简体中文	Displays prompts in Simplified Chinese.
Français-CA	Displays prompts in Canadian French.

Setting the Monetary Sign

The monetary sign is used in conjunction with option **42**. Refer to the *Packet Reference Manual* for more information. The setting for monetary sign applies when a format is downloaded. Changing the setting does **not** affect batches already in the printer.

The printer contains 16 different currency symbols.

Select **None** if you do not want a monetary sign to print in price fields.

Select	To
None	Does not print a monetary sign.
Dollar	Print the \$ sign.
Pound	Print the £ sign.
Yen	Print the ¥ sign.
Deutsche Mark	Print the ₰ sign.
Franc	Print the F sign.
Peseta	Print the P sign.
Lira	Print the L. sign.
Krona	Print the Kr sign.
Markka	Print the ₯ sign.
Shilling	Print the ₧ sign.
Rupee	Print the Rs sign.
Ruble/Rubel	Print the ₮ sign.
Won	Print the ₩ sign.
Baht	Print the ฿ sign.
Yuan	Print the ¥ sign.
Euro	Print the € sign.

Setting the Secondary Sign

If you select the dollar as the monetary sign, you can print amounts less than \$1.00 either by using a dollar sign and decimal (\$0.30) or by using a cent sign (30¢).

The secondary sign is used in conjunction with option **42**. Refer to the *Packet Reference Manual* for more information. The setting for secondary sign applies when a format is downloaded. Changing the setting does **not** affect batches already in the printer.

Select	To
No	Do not print a secondary monetary sign. prices under \$1.00 will print like this: \$.45
Yes	Print a secondary monetary sign. prices under \$1.00 will print like this: 45¢ The secondary sign also applies to monetary signs other than the dollar.

Setting the Number of Decimal Places

Set the printer for 0, 1, 2, or 3 places after the decimal in a price field. In dollar currency, you might print prices like this: \$24.00 (2 decimal places) or like this: \$24 (0 decimal places).

The decimal places are used in conjunction with Option **42**. Refer to the *Packet Reference Manual* for more information. The setting decimal places apply when a format is downloaded. Changing the setting does **not** affect batches already in the printer.

Select	To
0	Do not use decimal places. prices print as whole numbers: \$20
1	Print one place after the decimal. prices print like this: \$20.5
2	Print two places after the decimal. prices print like this: \$20.50
3	Print three places after the decimal. prices print like this: \$20.500

Setting the Slashed Zero Appearance

The slashed zero option lets you select how you want the zero character printed; either without a slash, 0 or, with a slash, Ø.

Standard or reduced fonts print the slashed zero character (Ø). Bold and OCR fonts print the standard zero (0) only. The slashed zero selection does **not** take effect until the format is sent to the printer again. If you change the way zero prints, you must resend your formats.

The setting for slashed zero applies when a format is downloaded. Changing the setting does **not** affect batches already in the printer.

Select	To
No	Do not print zeroes with a slash.
Yes	Prints zeroes with a slash (Ø).

Setting the Power-Up Mode

Power-up mode lets you decide how your printer starts each time you turn it on:

- ◆ Ready to receive data and start printing (online mode).
- ◆ Operator can select a format to print (offline mode).
- ◆ Operator can enter data for a selected format using a USB keypad (offline mode).

Select	To
Online	When the printer is turned on, you see “Ready.”
Offline	When the printer is turned on, you see Data Entry mode. Make sure formats are loaded into flash memory and a keyboard is connected if you need to enter data.

Setting the Numeric Format

Numeric format determines how numeric values appear in your printed data.

Select	To
Default	Latin numerals print in Latin; Arabic text prints in Arabic.
Arabic-Indic	Latin numerals print in Arabic; Arabic text prints in Arabic.
Eastern-Arabic	Latin numerals print in Arabic; Arabic text prints in Arabic.

Examples

Latin Characters: 95% cotton

Latin Numerals with Arabic Characters: %95 قطب

Arabic Numerals with Arabic Characters:

Arabic-Indic: %٩٥ بوليستر
Eastern-Arabic: %٩٥ بوليستر

Using Flash Storage

Packets (formats, fonts, graphics) stored in flash memory are saved when the printer is turned off.

Note: Before using flash storage, format flash memory. See “[Formatting Flash Memory](#)” for more information.

Select	To
Disabled	Does not allow flash storage.
Enabled	Allows flash storage for formats, fonts, and graphics.

Setting the Image Error Mode (No Image Error)

Image errors occur when there is a problem producing a complete label. Press **ESCAPE** to clear an image error.

Select	To
Disable	If a format does not print as expected, an error message appears on the display.
Enable	If a format does not print as expected, no error message appears and the format prints as is. For example, bar codes require a non-print zone; if a bar code is placed too close to the edge of the label, no error is reported and the bar code may not scan properly.

Image errors include:

600	unable to image batch	614	portion of field off label
601	problem during imaging	615	invalid PDF417 bar code data
603	missing batch	618	invalid font size
611	invalid font, bar code or density	620	missing font data
612	missing batch data	621	invalid downloaded font
613	reference point off label	622	not enough font memory

Error 616 (bar code dot shifting failed) is always reported.

Setting the Configuration Packet Mode (Ignore Config)

The printer can respond to or ignore all online configuration packets. Refer to the *Packet Reference Manual* for more information about online configuration packets.

We recommend changing your host's data stream, but if that is not possible, enable this option. Use caution if ignoring online configuration packets, because the printer may need the configuration for proper operation!

Select	To
Disable	The printer responds to all online configuration packets.
Enable	The printer ignores all online configuration packets. This is useful when you cannot change your host's data or when you want the printer to operate as specified through the printer's menu.

Setting the Batch Packet Mode (Ignore BchCtl)

The printer can respond to or ignore all batch control fields within batch packets. This option is available in firmware version 3.2 or greater. Refer to the *Packet Reference Manual* for more information about the batch control field.

Some third-party label design packages include batch control fields within a batch packet. The batch control field sets the following:

- ◆ feed mode
- ◆ cut mode
- ◆ verifier mode
- ◆ image rotation
- ◆ batch separators
- ◆ print multiple
- ◆ multiple part tags

The batch control field **overrides settings** made at the printer and in online configuration packets.

We recommend changing your host's data stream, but if that is not possible, enable this option. Use caution if ignoring the batch control field, because the printer may not operate as expected.

Select	To
Disable	The printer responds to all batch control fields within a batch packet.
Enable	The printer ignores all batch control fields within a batch packet. This is useful when you cannot change your host's data or when you want the printer to operate as specified through the printer's menu.

Setting the Error Retry Mode

The printer either reprints the job or discards/cancels the job after a supply error is cleared. Depending on your environment, you may not want jobs reprinted.

Select	To
Disable	The printer discards the job that was in process and does not reprint it.
Enable	The printer reprints the job that was in process when the error occurred.



Selecting **Disabled** can result in losing up to four tags/labels.

Adjusting the Image Length

Using this setting requires continuous (non-indexed) supply. The printer ignores this setting (does not error) when using other supply types. This setting increases or decreases the image length based on the percentage entered. Values are in tenths of a percent.

If a print image is defined close to the label's edge and adjust image length is set **to a negative value**, the printed image may not be complete. Some of the image may be lost. Verify your printed image is complete.

Examples

Format A is 10.0 inches long (as defined in the format header).

Image Length is +20

Format A prints 10.20 inches long.

Format B is 6 inches long (as defined in the format header).

Image Length is -30

Format B prints 5.82 inches long.

Refer to the *Packet Reference Manual* for more information about defining the format header.

Select	To
←	Decrease the setting. Reduces the image length by the entered percentage.
→	Increase the setting. Increases the image length by the entered percentage.

Press **1** to toggle the amount (1, 10, or 100).

Setting the Sleep Delay

When the printer is idle for a selected period of time, it goes into sleep mode to conserve power. Adjust the sleep delay setting from 1 minute to 240 minutes. The default setting is 60 minutes. The printer wakes from sleep mode when it receives a print job, a button is pressed, or the printhead is opened/closed.

Select	To
←	Decrease the inactivity time before the printer goes into sleep mode.
→	Increase the inactivity time before the printer goes into sleep mode.

Press **1** to toggle the amount (1, 10, or 100).

Setting the LCD Contrast

With version 1.9 or greater firmware, adjust the contrast (brightness) of the LCD. The range is 1 to 9. The default is 3.

Select	To
←	Decrease the LCD contrast (make the display lighter).
→	Increase the LCD contrast (make the display darker).

Setting the Format Number Mode (Ignore Fmt #s)

The printer can respond to or ignore format numbers. Format numbers are used within the format and batch header in each format and batch packet created. Refer to the *Packet Reference Manual* for more information about creating format and batch packets.

When using third-party software packages, use caution if ignoring format numbers, because print jobs may not print the expected data! If you are not sure how print jobs are sent, **do not enable this option**. Call Technical Support for more information.

Select	To
Disable	<p>The printer responds to all format/batch numbers and images print jobs as expected.</p> <p>The printer receives a format, followed by multiple batches referencing that format (Format/Batch/Batch/Batch). For example:</p> <p>{F,1,..} {B,1...} {B,1...} {B,1...}</p>
Enable	<p>The printer ignores all format numbers, which may improve imaging throughput when jobs are sent as format/single batch pairs. The printer's buffers are optimized to receive a format, followed by a single batch that references that format.</p> <p>The printer may pause between batches to replace the previous format with the new format. If ignore format numbers is enabled, this pause may be reduced and image/print jobs faster.</p> <p>Only enable this option when print jobs are sent as a format, followed by a single batch referencing that format number and repeated. For example:</p> <p>{F,10,..} {B,10...} {F,10...} {B,10...} {F,10,..} {B,10...}</p> <p>Note: The format being sent repeatedly MUST have the same format number (for example, format 10).</p> <p>However, enabling this option may have unexpected results. For example, sending this data:</p> <p>Format 1 {F,1,...} format number (1) is ignored Format 2 {F,2,...} format number (2) is ignored Batch 1 {B,1,...} format number (1) is ignored</p> <p>Prints with Batch 1 data applied to Format 2, because the printer ignores the format numbers and associates batches with only the preceding format.</p>

Using a Temporary Graphics Buffer

The printer stores temporary graphic data in the image buffer until the graphic is printed, then it is cleared from memory.

However, when using multiple temporary graphics, enable a temporary **graphics** buffer to quickly image/print them.

Select	To
Disable	The printer uses the default image buffer. This is the default. The printer may pause between printing labels with different temporary graphics on each label.
Enable	The printer uses a temporary graphics buffer. Using this buffer allows the printer to image and print temporary graphics without pausing between printing labels.

Using Flash Memory

Use these basic guidelines when storing files in your printer's flash memory.

- ◆ Your printer has volatile RAM (packets deleted when the printer is off) and flash memory (packets saved when the printer is off).
- ◆ Flash memory must be formatted before any packets can be saved. See "[Formatting Flash Memory](#)" for more information.
- ◆ Formats, graphics, and check digits can be saved in flash (a copy is automatically placed in RAM). Any packets saved in flash cannot exceed the memory available in RAM.
- ◆ There is not a 1-to-1 ratio between the RAM memory (formats, graphics, and check digits) in your printer and the memory in your PC. For example, a file that is 5K in Windows may require 15-20K to store in your printer.
- ◆ Use temporary storage for graphics that are only used once or twice. However, if you have a logo that is used on multiple formats, save the graphic in flash.
- ◆ Each line in a packet requires the same amount of memory. The smaller the format, the less memory required to save it.

The flash memory options are in the table below.



Option	Choices	Default
Format Flash	No/Yes	No
Unused Flash	NA	NA
Pack Flash	No/Yes	No

Formatting Flash Memory

Before storing packets in flash memory, downloading a script, or updating the printer's firmware, you must format the flash memory. **Formatting flash memory is only required once during initial printer setup.**

Select	To
No	Does not format flash memory.
Yes	Formats flash memory. The printer's flash memory is cleared and reformatted. <i>This process may take several minutes.</i> The printer reboots automatically after formatting flash memory Any scripts, downloaded fonts, formats, or graphics saved in the printer's flash memory are deleted and must be resent to the printer.

Viewing Available Flash Memory

If you receive errors when downloading a script or other packets, make sure you have enough flash memory available.

Select	To
Unused Flash	View the amount of available flash memory in bytes. Divide this number by 1024 to get the number of available kilobytes. Make sure your font or ADK script files do not exceed this amount.

Packing Flash Memory

Packing flash memory permanently removes any deleted files from memory.

Select	To
No	Does not pack flash memory.
Yes	Packs flash memory. Frees space previously occupied by deleted files.

Using a USB Thumb Drive

Using a USB thumb drive, you can update

- ◆ Printer bootloader (**r46*.bin**)
- ◆ Printer firmware (**a46*.bin**)
- ◆ RFID firmware (**a84*.bin**)
- ◆ RFID inlay database (**d46ES*.db**)

The USB thumb drive must be FAT32 format.

Only a qualified Service Representative may update the bootloader, printer's firmware, and RFID firmware.

Updating the RFID Inlay Database

The printer contains an RFID inlay database (**d46ESxx.db**). The RFID database is included with the printer's firmware and does not need to be flashed separately. However, new inlays may be qualified in between firmware releases. Only inlays qualified for use in the printer are included. The **xx** in the filename indicates the revision level of the database.

To update the RFID Database:

1. Create an **ADTP** folder on your thumb drive.
2. Download the necessary file (**d46ESxx.db**) from our website.
3. Save the file to the **ADTP** folder on your thumb drive.
4. Turn on the printer. When you see "Ready", insert the thumb drive into the USB port.



5. Press **MENU** and use **←** or **→** to select the Setup menu, USB Drive.



6. Press **ENTER** and use **←** or **→** and select the RFID Database file.



7. Press **SELECT**.

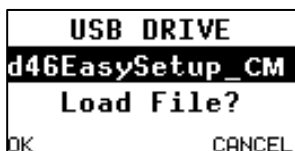

8. Press **OK**. The progress is shown on the display:

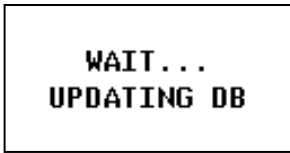

USB Drive Troubleshooting Information

You may receive these messages while using a USB thumb drive.

Problem	Action
	Insert the thumb drive into a USB port.
	Files on the thumb drive must be saved into a folder named ADTP , not ADTP2 or the root.

Setting the Clock (Optional)

The EF version (extended features) printer contains a real-time clock. Set the clock during initial printer setup.

The printer keeps track of the date and time even when the printer is turned off. The clock does not adjust for daylight saving time.

The clock options are in the table below.



Option	Choices	Default
Hour	0 to 23	0
Minute	0 to 59	0
Day of Month	1 to 31	1
Month	1 to 12	1
Year	00 to 99	0

Setting the Hour

Set the clock's time for hours. The clock operates on 24-hour time.

Select	To
0 - 12	Sets the hour to the specified time (AM).
13 - 23	Sets the hour to the specified time (PM). For example, 16 is 4:00 PM.

Setting the Minute

Set the clock's time in minutes.

Select	To
0 - 59	Sets the time in minutes to the specified time.

Setting the Day of the Month

Set the clock's day of the month.

Select	To
1 - 31	Sets the day of the month to the specified number.

Setting the Month

Set the clock's month.

Select	To
1	Sets the clock to January.
2	Sets the clock to February.
3	Sets the clock to March.
4	Sets the clock to April.
5	Sets the clock to May.
6	Sets the clock to June.
7	Sets the clock to July.
8	Sets the clock to August.
9	Sets the clock to September.
10	Sets the clock to October.
11	Sets the clock to November.
12	Sets the clock to December.

Setting the Year

Set the clock's two-digit year.

Select	To
00 to 99	Sets the year to the specified number. For example, 19 indicates year 2019.

Selecting the Interpreter

The printer includes four Interpreter options.



The printer reboots automatically after selecting an interpreter. This process may take several seconds.

When you see "Ready," the selected interpreter appears in the upper left-hand corner of the display.

The interpreter options are in the table below.

Option	Choices	Default
Interpreter	MPCL/MLI/WMS XML	MCPL

Select	To
MPCL	Use the MPCL interpreter. Refer to the <i>Packet Reference Manual</i> on our Web site for more information.
MLI	Use the MLI interpreter. Refer to the <i>MLI Quick Reference</i> on our Web site for more information. When you print test labels, the model number appears as ADTP2 (MLI) .
WMS XML	Use the XML interpreter. Refer to the <i>XML Quick Reference</i> on our Web site for more information. When you print test labels, the model number appears as ADTP2 (XML) .

USING SCRIPTS

This chapter explains how to load, enable, and delete scripts. You can also enable status polling and immediate commands.

Using the Scripts menu requires custom software. Scripts can print data streams written for other printers or define a lookup table. Contact us to create a custom script for your printer.

You can limit access to this menu to prevent changes.



The script options are in the following table:

Option	Choices	Default
Load Script	No/Yes	No
Enable Script	No/Yes	No
Script Info	NA	NA
Delete Script	No/Yes	No
Status Polling	Disable/Enable	Disable
Immediate Commands	Disable/Enable	Disable

Initial Script Startup Procedures

Before you can start using a script, check the following items:

- ◆ Check to see if a script is already in the printer. See "[Viewing Script Information](#)" to continue.
- ◆ Format flash memory, if needed. See "[Formatting Flash Memory](#)" in Chapter 6 for more information.
- ◆ Download a script to the printer, if needed. See "[Downloading a Script](#)" to continue.

Viewing Script Information

You can view information about a loaded script.

Select	To
Script Info	View the information about the loaded script. If a script is not loaded, you see "No script loaded." If a script is loaded, you see the script name and version number.

If a script is already loaded, see "[Enabling a Script](#)," to continue. If you need to download a script, see "[Formatting Flash Memory](#)" in Chapter 6.

Downloading a Script

Follow these instructions to download a script from the command prompt. Set the communication parameters using the MODE command. Then, prepare the printer to accept a script. Select **Load Script** from the printer's menu:

Select	To
No	Keeps the existing script (if one is loaded). The printer is not ready to accept a script file.
Yes	Deletes the existing script on the printer. Prepares the printer to accept a new script file.

Note: Only one script can be loaded in the printer at a time.

Send the script file to the printer.

When downloading a script, if you receive an error:

- ◆ Check the available flash memory. See "[Viewing Available Flash Memory](#)" in Chapter 6 for more information.
- ◆ Format flash memory. See "[Formatting Flash Memory](#)" in Chapter 6 for more information.

After downloading a script, if the script does not appear to be loaded, try formatting flash memory and download the script again.

Enabling a Script

The script must be enabled before you can use it.

Select	To
No	Does not enable the script. (Stop the script).
Yes	Start the script. When you turn the printer off and back on, the script automatically starts. When you see "Ready," the word "Script" appears in the upper left-hand corner of the display.

When a script is not loaded, this message appears:



Deleting a Script

You can delete a script from the printer's memory.

Select	To
No	Does not delete the script.
Yes	Deletes the script.

The flash memory used by the script is not available for other scripts or fonts until the flash memory is reformatted. However, when you format flash memory, you must resend the script and any downloaded fonts to the printer.

Enabling Status Polling

Status polling allows you to obtain information about the readiness of the printer and the current (or last received) print job.

Select	To
Disable	Do not use status polling.
Enable	Use status polling.

Using Immediate Commands

You can use immediate commands to reset the printer or cancel and repeat batches. Immediate commands are turned on or off through an MPCL packet. Refer to the *Packet Reference Manual* (available on our Web site) for more information about immediate commands and control characters.

Use this option to set whether the ADK script processes or ignores an immediate command control character.

Select	To
Disable	ADK script ignores an immediate command control character. Instead, the immediate command control character and immediate command are treated as data.
Enable	ADK script processes an immediate command control character and performs the requested immediate command.

SETTING RFID OPTIONS

The RFID printer has been engineered to encode (program) an RFID (Radio Frequency Identification) inlay while printing. RFID inlays contain an embedded programmable microchip and an antenna. The printer supports EPC Class-1 Generation-2 UHF (C1Gen2) protocol encoding. To create a format with an RFID data field and program RFID data, refer to the *Packet Reference Manual*.

An RFID printer has an antenna to program RFID inlays. Two antenna modules are available – one for FCC and one for ETSI frequencies. The antenna module type prints on the RFID configuration label. See “[Printing a Test Label](#)” for more information.

An optional external verifier (reader) is available to verify the data within a programmed RFID inlay. The antenna is located within the supply path. The optional external verifier is located where the supply exits the printer. Peel mode or liner take-up is not available with optional external RFID verifier.

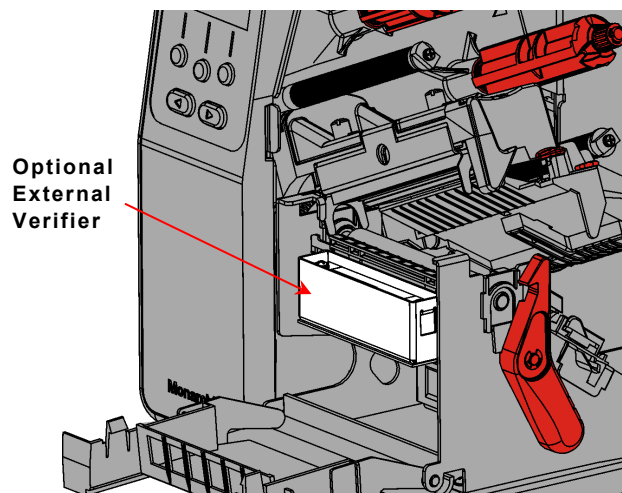
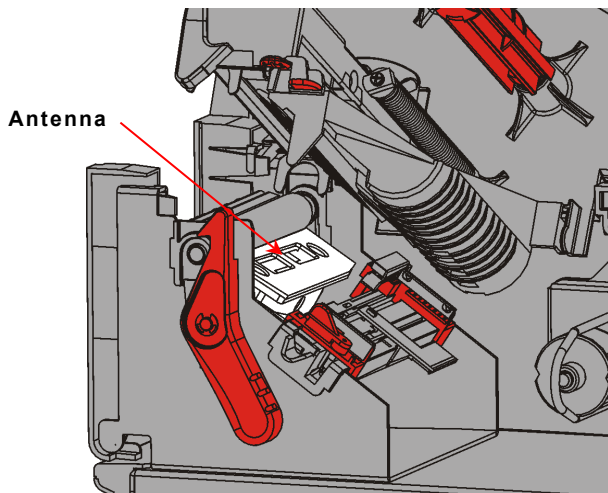

The RFID printer operates in one of **two** modes:

- ◆ non-stop encode mode In non-stop encode mode, the printer does not pause (or stop) while encoding the RFID inlay. Non-stop encode is useful with minimum “pitch” supplies. See “[What is Pitch](#)” for more information.
- ◆ stop-to-encode mode In stop-to-encode mode, the printer pauses (or stops) while encoding the RFID inlay.

About RFID Supplies



RFID supplies can be damaged by static electricity. Ground yourself by touching metal, such as the printer’s metal base, before handling the RFID supplies.

Do not use skip index with RFID supplies.

Many different RFID supplies are available – each chip has different amounts of available programmable EPC data, user memory, access password, and lock code data. For example, some chips such as the Impinj Monza R6 can only be permalocked. Refer to the *Packet Reference Manual* for more information.

Printing over the RFID inlay causes printing irregularity and may impact bar code print quality.

What is Pitch?

Pitch is the length of the label measured from the leading edge of one label to the leading edge of the next label as shown. Pitch includes the gap between die cut labels.

When using a short supply length, enable singulate mode to prevent adjacency issues.

- ◆ Die cut supplies: Measure from the leading edge of one label to the leading edge of the next label.
- ◆ Black mark supplies: Measure from the top of one black mark to the top of the next black mark.
- ◆ Aperture supplies: Measure from the top of one aperture hole to the top of the next aperture hole.

The leading edge is the edge of the label that exits the printer first; regardless of how the format is designed on the label.

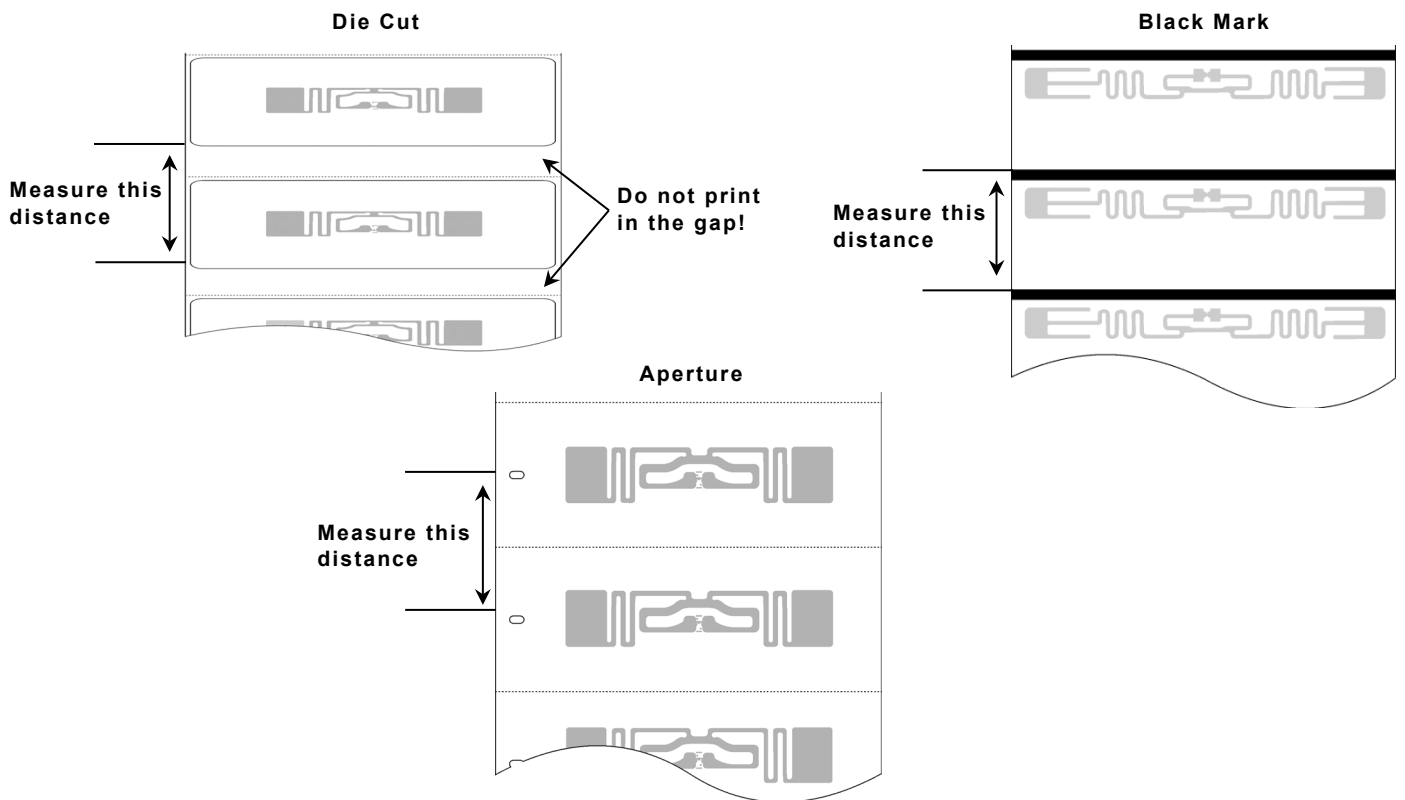

Getting Started With RFID

The printer's RFID menu has three options: Auto Calibration, Easy Setup, and Advanced Setup. The preferred methods of RFID setup are:

- 1) Use the Auto Calibration Menu to automatically configure the printer. Firmware version 4.0 or higher.
- 2) Use the Easy Setup Menu when you know the inlay type and inlay position. See "Using the Easy Setup Menu."
- 3) Use the *Monarch® RFID Printer Setup Utility* to help determine the printer's required read/write powers, positional settings, etc. Find this Web-based utility at <http://printers.averydennison.com/en/home/resources/service-and-support/rfid-printer-setup-utility.html>

The advanced setup menu is for advanced users. See "[Using the Advanced Setup Menu](#)" for more information.

Using the Auto Calibration Menu

Use Auto Calibration to determine the RFID read/write settings and print speed.



Auto Calibration options include:

Option	Choices	Default
Encoder	Runs auto calibration using the encoder	N/A
Verifier	Runs auto calibration using the verifier	N/A
Power	Normal, High *use Normal unless otherwise directed by Avery Dennison	Normal

- ◆ Load RFID supply into the printer (refer to the Operator's Handbook for details). Expect to use 5-7 labels each time auto calibration runs. Auto Calibration can take up to three minutes to complete. After Auto Calibration is complete, the supplies may be re-rolled for use/printing. No inlays are encoded and nothing is printed during Auto Calibration.
- ◆ Auto Calibration accounts for slight variations between printers and supply, we recommend running Auto Calibration on each of your printers.
- ◆ Auto Calibration will fail if the supply contains non-functional inlays. Visually inspect your RFID supplies to ensure that no marked inlays or other defects are used in the calibration process.
- ◆ Auto Calibration is only for use with non-stop encoding (typically used for batch printing). Use the other documented methods to obtain read/write settings if you are printing and encoding in on-demand mode.
- ◆ Auto Calibration sets the print speed to the highest possible based on the ability to reliably encode the inlays. You may need to adjust the print speed DOWN to improve print quality and/or if you are writing more than 96-bits to the EPC.
- ◆ Run Auto Calibration after any changes in supply or inlay type.

Successful Auto Calibration

When auto calibration is successful you see a green success message, click OK. RFID settings and print speed are automatically set. Run a test RFID job of at least 10 labels, print EPC information on each label. Read a few random labels to make sure the programmed tag matches the printed EPC information.

Unsuccessful Auto Calibration

If a motion error occurs (supply jam, out of supply, etc.) during calibration, the error is reported with an error number. Click **OK** to acknowledge the error. Correct the error and retry auto calibration.

Failed Auto Calibration

If an auto calibration-specific error occurs, you see “Auto Calibrate Failed”. Click **OK** to acknowledge the error. Press Feed to feed a blank label and repeat Auto Calibration. If it fails a second time, re-inspect the supply. Be sure there are no bad inlays. Repeat Auto Calibration. If the process fails a third time, contact Service.

Using the Easy Setup Menu

With Easy Setup, enter two parameters for RFID to quickly start encoding RFID inlays. The inlay type and inlay position (in millimeters) may be printed on the RFID supply roll core’s label.. *Easy Setup is only for use with non-stop encoding.*



The Easy Setup options include:

Option	Choices	Default
Select Inlay	various	N/A
Inlay Pos [mm]	0-200	0

The printer contains a RFID inlay database (**d46ESxx.db**). If the database is not already installed in your printer, download it from the *RFID Printer Setup Utility*:

<http://printers.averydennison.com/en/home/resources/service-and-support/rfid-printer-setup-utility.html>

Check the *RFID Printer Setup Utility* for database updates and downloads if your inlay type is not listed. Only inlays qualified for use in the printer are included in the database. See “[Updating the RFID Inlay Database](#)” for more information

Once the inlay and inlay position are entered, the printer uses its RFID inlay database to configure the:

- ◆ correct inlay read/write power levels
- ◆ inlay position settings
- ◆ singulate mode and TID position (if necessary)
- ◆ speed (decrease as necessary)

Once a batch is sent to the printer, the printer begins encoding and printing.

The RFID settings in the Easy Setup Menu and the RFID Printer Setup Utility are based on encoding 96-bits of EPC data with a lock code. If your RFID data is more complex than 96-bits of EPC data with a lock code, you may need to decrease the printer's speed in non-stop encode mode. See "[Setting the Speed](#)" for more information. The following examples may require a decreased print speed:

- ◆ encoding 96-bits of EPC data and programming user memory
- ◆ encoding more than 96-bits of EPC data with a lock code
- ◆ encoding more than 96-bits of EPC data and programming user memory

More information about the RFID values the printer *automatically* sets in Easy Setup can be found in [Using the Advanced Setup Menu](#).

Selecting the Inlay

This option only appears in the Easy Setup menu. You must know the name of the RFID inlay being used. **Names and pictures of the approved inlays are in the *RFID Printer Setup Utility*.** Load RFID supply before you enter values in the Easy Setup menu.

The printer contains a list of approved inlays. If your RFID inlay is not listed, it may not be qualified for use or update the printer's RFID inlay database (**d46ESxx.db**). See "[Updating the RFID Inlay Database](#)" for more information. The *RFID Printer Setup Utility* has database updates and downloads.

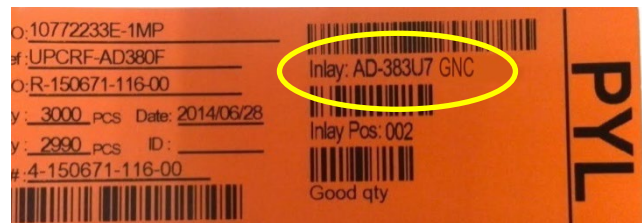

1. The inlay's name may be on the supply core's label; otherwise, look at pictures of the approved inlays in the *RFID Printer Setup Utility*. For example, AD-383U7 GNC.
2. Press ← or → to select your inlay, then press **SET**. "Custom" appears as the selected inlay's name if the print speed is increased or any RFID settings are changed.

Entering the Inlay Position

This option only appears in the Easy Setup menu. The inlay position must be entered in millimeters. Measure the inlay position as shown to the nearest whole millimeter. For example, if the measured distance is 7.25mm, enter 7mm.

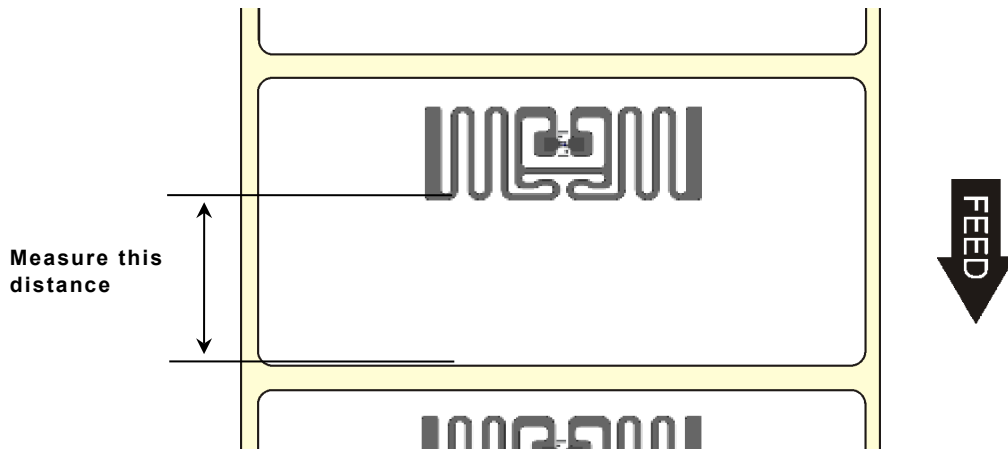

1. The inlay's position (in millimeters) may be on the supply core's label. For example, enter 002 as 2.
3. Enter the inlay's position, then press **SET**.

Select	To
←	Decrease the inlay distance.
→	Increase the inlay distance.

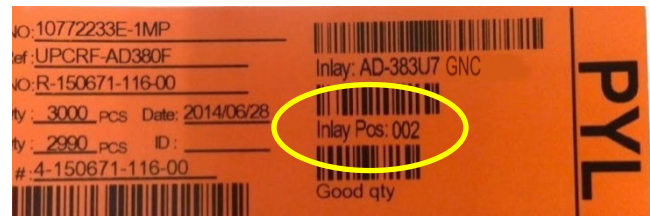

Press **1** to toggle the amount (1, 10, or 100).

The printer may prompt to calibrate when exiting the Easy Setup menu. Press **START** to calibrate or **STOP** to cancel. The calibration prompt appears when the inlay type or the inlay distance changes.



Using the Advanced Setup Menu



The preferred methods of RFID setup are:

- 1) Using the Easy Setup Menu to quickly configure the printer.
- 2) Using the *Monarch® RFID Printer Setup Utility* to configure the printer's read/write powers, positional settings, etc. Find this Web-based utility at <http://printers.averydennison.com/en/home/resources/service-and-support/rfid-printer-setup-utility.html>

The advanced setup menu is for advanced users. Changing settings in the advanced menu is not typically recommended.

Adjust these settings **only if** errors are received when using values from Easy Setup or the *RFID Printer Setup Utility*. Adjusting these settings may cause undesired results.

The advanced setup menu changes whether non-stop encode mode or stop-to-encode mode is selected.

The Advanced Setup options include:

Option	Choices	Default	Non-Stop Encode	Stop-to-Encode
Stop-To-Encode Mode	Yes/No	No	X	X
Singulate Mode	Yes/No	No	X	X
Write Power	-15 to 23	-15	X	X
Read Power	-15 to 23	-15	X	X
Encode Position	0 to 2000	0		X
Tag Saver	Yes/No	No	X	
First TID Position	0 to 2000	0	X	
Start Encode Position	10 to 2000	100	X	
Encode Zone	50 to 2000	200	X	
Tag Verify	None/Internal/External/Both	None	X	X
Verify Power	-15 to 23	-15	X	X
Tag Verify Position	10 to 2000	100	X	X
Retry Encode	Enable/Disable	Enable	X	X
Clear Data	Yes/No	No	X	X

Use the *RFID Printer Setup Utility* to calculate the required positional settings.

Setting Stop-To-Encode Mode

This option only appears in the Advanced Setup menu. The printer operates in non-stop encode or stop-to-encode mode. The default is non-stop encode.

Select	To
Yes	<p>Use stop-to-encode mode. The printer pauses (or stops) while encoding the RFID inlay.</p> <p>The printer feeds supply, stops to encode the inlay, then prints the image. Backfeeding may occur to properly position an inlay over the antenna. An inlay is encoded then the label is imaged/printed.</p> <p>Stop-to-encode mode may yield faster throughput with specifically configured supply.</p>
No	<p>Enable non-stop encoding. The printer does not pause (or stop) while encoding the RFID inlay.</p> <p>Encoding and printing is done at the same time.</p> <p>Non-stop encoding is required for minimum pitch supplies. See "What is Pitch" for more information.</p>

Performance Considerations with RFID

The printer has two RFID modes of operation: stop-to-encode and non-stop encode:

Stop-to-encode mode	Non-stop encode mode
<ul style="list-style-type: none"> ◆ The printer pauses (or stops) while encoding the RFID inlay. 	<ul style="list-style-type: none"> ◆ The printer does not pause (or stop) while encoding the RFID inlay.
<ul style="list-style-type: none"> ◆ The amount of programmable EPC data, user memory, access password, and lock code data varies by RFID chip. 	<ul style="list-style-type: none"> ◆ Some RFID chips encode faster than others.
<ul style="list-style-type: none"> ◆ The printer errors if it cannot program all the RFID data within the allotted time. 	<ul style="list-style-type: none"> ◆ The faster the print speed, the less time the printer has to encode data.
<ul style="list-style-type: none"> ◆ Stop-to-encode mode must be used for serialized EPC data. Refer to the <i>Packet Reference Manual</i> for more information. 	<ul style="list-style-type: none"> ◆ The amount of programmable EPC data, user memory, access password, and lock code data varies by <i>print speed</i> and RFID chip. ◆ The printer errors if it cannot program all the RFID data while the inlay is within the encode zone.

Enabling Singulate Mode

This option only appears in the Advanced Setup menu. The default is no.

When singulate mode is enabled, set the first TID position. See “[Setting the First TID Position](#)” for more information.

Select	To
Yes	<p>Enable singulate mode. The printer uses low power to read the unique TID field of the RFID inlay over the printer’s antenna. Then the printer uses this TID number to program (with a higher write power) <i>only</i> that specific inlay.</p> <p>Use singulate mode to avoid adjacency issues with minimum pitch supplies. Adjacency issues occur when leading or trailing RFID inlays are encoded instead of the inlay over the antenna.</p> <p>Note: While singulate mode is more reliable, it may decrease throughput.</p>
No	<p>Disable singulate mode. The printer does not use the TID field to program a specific inlay.</p>

Setting the Write Power

This option only appears in the Advanced Setup menu. The write power setting increases the strength of the RF Field emitted by the printer’s antenna. Use this power to encode (program) the RFID inlay. The range is -15 to 23. The default is -15.

Use the *RFID Printer Setup Utility* to determine the write power then enter the value at the printer.

Select	To
←	<p>Decrease the setting.</p>
→	<p>Increase the setting. The higher the value, the greater the power of the RF Field. If the Write power setting is too high, you may change the data that was programmed into adjacent RFID inlays.</p>

Press **1** to toggle the amount (1, 10, or 100).

Setting the Read Power

This option only appears in the Advanced Setup menu. The read power setting increases the strength of the RF Field emitted by the printer's antenna. Use this power to read tags in singulate mode. The range is -15 to 23. The default is -15.

Use the *RFID Printer Setup Utility* to determine the read power then enter the value at the printer.

Select	To
←	Decrease the setting. If the read power setting is too low, the RFID inlay in the RF field may not be read.
→	Increase the setting. If the read power setting is too high, adjacent RFID inlays may be read.

Press **1** to toggle the amount (1, 10, or 100).

Setting the Encode Position

This option only appears in the Advanced Setup menu *when using stop-to-encode mode*. The encode position is measured from the leading edge of the supply to the best programming position within the inlay. The encode position is different for each type of inlay. The range is 0 to 2000. 0 is the default, which indicates the printer does not have to reposition the inlay.

Set this position *only* when using stop-to-encode mode. *When using a 0 encode position*, the printer encodes when the label is at the defined top-of-form position – no extra supply movement is required. When using a **non-zero** encode position, the printer automatically backfeeds between labels, thereby **decreasing throughput**.

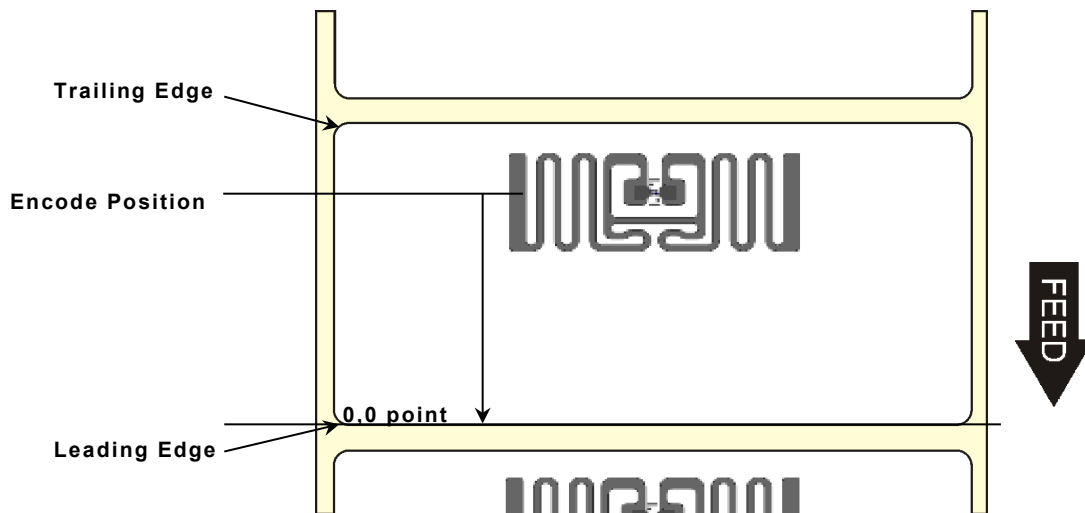

Use the *RFID Printer Setup Utility* to determine the encode position then enter the value at the printer.

Select	To
←	Decrease the setting.
→	Increase the setting.

Press **1** to toggle the amount (1, 10, or 100).

Enabling Tag Saver

This option only appears in the Advanced Setup menu. Not all RFID supplies support tag saver. The default is no.

Select	To
Yes	Enable tag saver. The printer moves the first tag in the batch backwards to the proper position before encoding. Note: Some supplies are sensitive to backfeeding and may cause jams.
No	Disable tag saver. The printer does not move the first tag in the batch backwards before encoding. If tag saver is disabled and an error occurs during external verification, the tag with an error does not have an overstrike pattern.

Setting the First TID Position

This option only appears in the Advanced Setup menu. The first TID position is only used in non-stop encode mode with singulate mode enabled. The range is 0 to 2000. The default is 0. The first TID position moves the 'hotspot' of the first inlay over the antenna so the TID order can be calculated. This process is only used on the first inlay, trailing inlays use the start encode position for setup. The 'hotspot' is the antenna's most sensitive programming area, which varies for each type of inlay.

The first TID position should "trail" after the start encode position; otherwise, error 737 occurs.

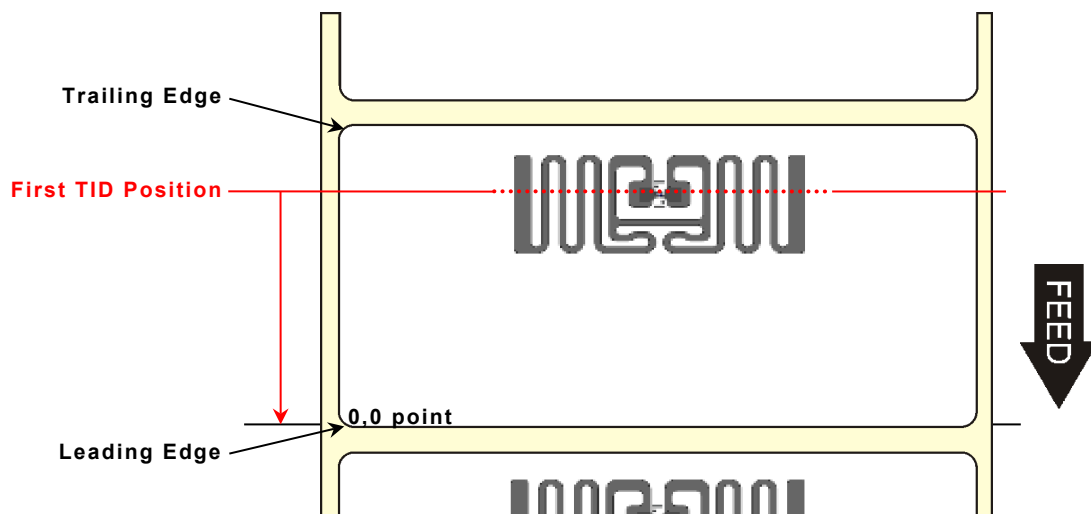

Use the *RFID Printer Setup Utility* to determine the first TID position then enter the value at the printer.

Select	To
←	Decrease the setting.
→	Increase the setting.

Press **1** to toggle the amount (1, 10, or 100).

Setting the Start Encode Position

This option only appears in the Advanced Setup menu. The start encode position is *only used in non-stop encode mode*. The printer uses this initial starting position to look for the RFID inlay to program while moving the supply. The range is 10 to 2000. The default is 100.

The start encode position is measured from the leading edge of the supply to the beginning of the RFID inlay encoding area in 0.01 inches.

The start encode position must “lead” (be before) the first TID position; otherwise, error 737 occurs.

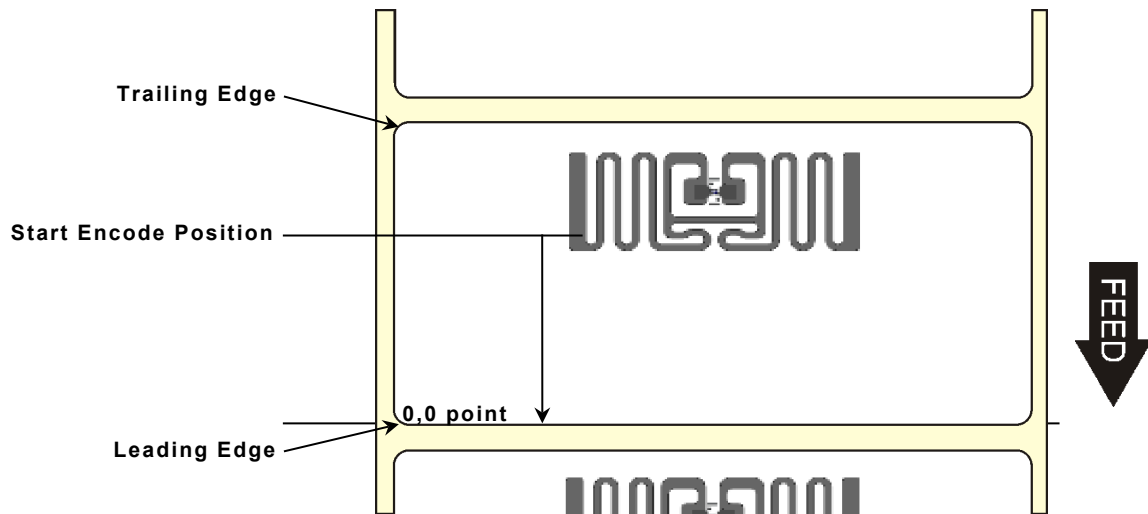

Use the *RFID Printer Setup Utility* to determine the start encode position then enter the value at the printer.

Select	To
←	Decrease the setting.
→	Increase the setting.

Press 1 to toggle the amount (1, 10, or 100).

Setting the Encode Zone

This option only appears in the Advanced Setup menu. The encode zone is *only used in non-stop encode mode*.

The encode zone is the area where the antenna and inlay communicate with each other during programming as the inlay moves over the antenna. It is the length in dots of the programming zone (area). The range is 50 to 2000. The default is 200.

The encode zone should not exceed the pitch of the label. If the encode zone is too large, adjacency issues may occur. See "[What is Pitch](#)" for more information.

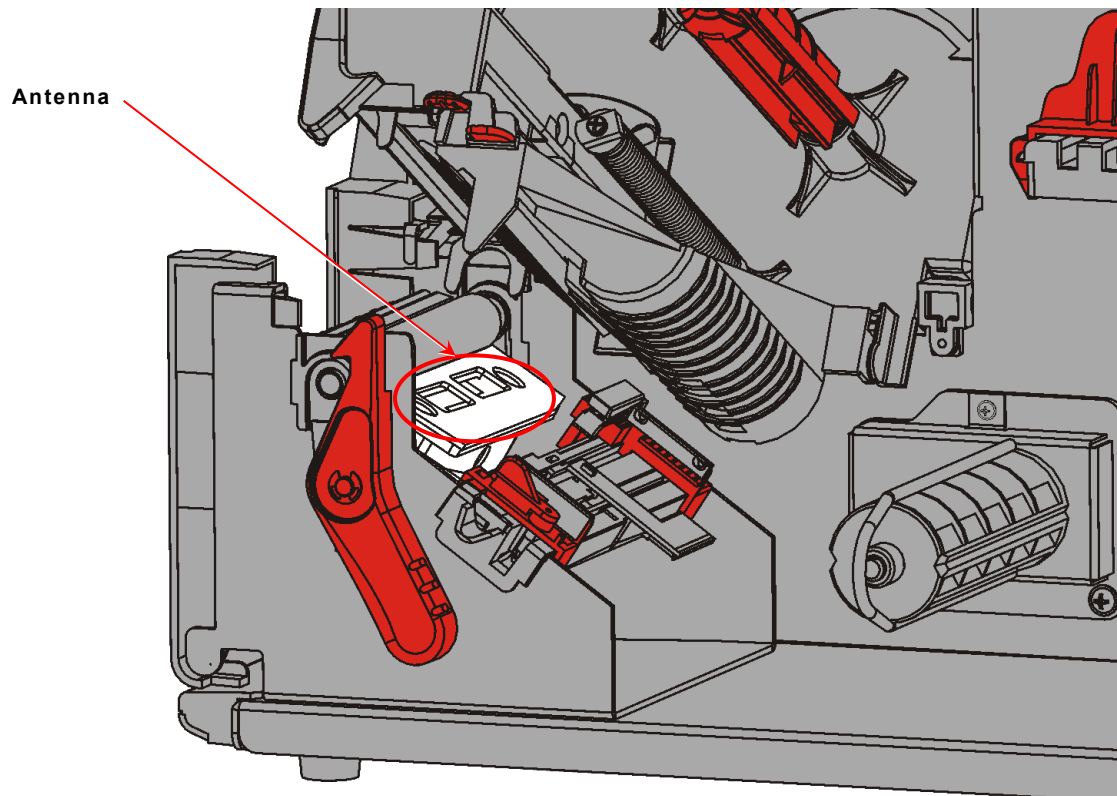

Use the *RFID Printer Setup Utility* to determine the encode zone then enter the value at the printer.

Select	To
←	Decrease the setting.
→	Increase the setting.

Press **1** to toggle the amount (1, 10, or 100).

Verifying the RFID Inlay Data

This option only appears in the Advanced Setup menu. The RFID printer can read/verify the RFID data programmed into an RFID inlay. The default is none.

Note: To externally verify/read programmed RFID data, purchase the optional external verifier.

Exit cover is shown open for visibility. The exit cover does not need to be opened.

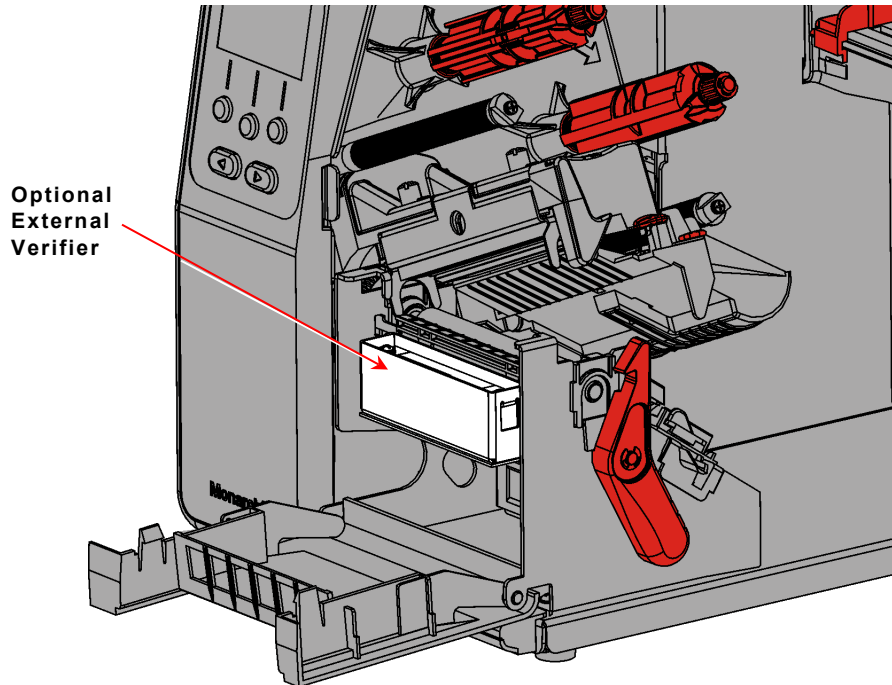

Select	To
None	Do not verify the programmed RFID data.
Internal	Confirms the read EPC data matches the programmed EPC data using the internal antenna.
External	Confirms the read EPC data matches the programmed EPC data using the optional external verifier. Requires setting the tag verify position. This option should not decrease throughput because verifying an inlay keeps up with the encoding speed.
Both	Confirms the read EPC data matches the programmed EPC data using the internal antenna and optional external verifier. Requires setting the tag verify position.

Enabling internal or both may decrease throughput.

When External or Both is selected, a checkmark icon appears on the display for a half second once external verification is successful.

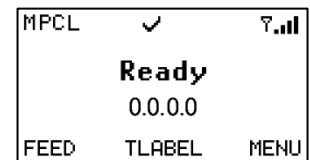

Setting the Verify Power

This option only appears in the Advanced Setup menu. The verify power setting increases the strength of the RF Field emitted by the printer's antenna. Use this power to read a programmed tag. The range is -15 to 23. The default is -15.

Use the lowest power possible to avoid any interference with the internal antenna. Interference may occur between the external verifier and internal antenna because of their close proximity.

Use the *RFID Printer Setup Utility* to determine the verify power then enter the value at the printer.

Select	To
←	Decrease the setting. If the verify power setting is too low, the RFID inlay in the verifier's field may not be read.
→	Increase the setting. If the verify power setting is too high, adjacent RFID inlays may be read.

Press **1** to toggle the amount (1, 10, or 100).

Setting the Tag Verify Position

This option only appears in the Advanced Setup menu. The tag verify position is *only used when Verify is set to external or both*. Sets the position for when the label's leading edge reaches the external verifier. The range is 10 to 2000. The default is 100.

If you continuously receive error 748 (verify mismatch) or 749 (RFID verify fail), adjust the tag verify position.

Use the *RFID Printer Setup Utility* to determine the tag verify position then enter the value at the printer.

Select	To
←	Decrease the setting.
→	Increase the setting.

Press **1** to toggle the amount (1, 10, or 100).

Enabling Retry Encode

This option only appears in the Advanced Setup menu. The default is enabled.

Select	To
Enable	The printer tries to reprint and program a label where a supply error occurred. The printer uses the same EPC data from the errored label on the next label. Use with incrementing batches.
Disable	The printer does not re-use the same EPC data. Once EPC data is already programmed into an inlay, the printer will not program that same EPC data again. For example, printing a batch of 100 labels prints 99 labels (or less) if a supply error occurs.

Clearing Data

This option only appears in the RFID Advanced menu. The printer keeps track and stores the following items:

- ◆ The number of RFID inlays successfully programmed.
- ◆ The number of RFID inlays that failed programming.

Depending on your application and volume of labels printed, clear this data daily or after each batch.

Select	To
Yes	Clear (erase) all RFID data collected since the last time it was cleared.
No	No data is erased. This is the default.

Using the Read Tag Option

Use the Read Tag menu option to read the data of an encoded RFID tag. Place the encoded RFID tag over the reader then select Read Tag from the menu.

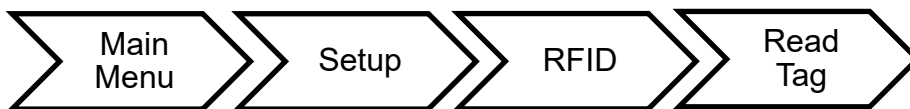

RFID Troubleshooting with Non-Stop Encoding

If the RFID printer is not encoding inlays, print a configuration label to check the module type and region of use. If the module type and region of use are not compatible, call Technical Support.

Try sending the print job with the printer's speed set to 2.5 ips, disable tag saver, and disable RFID verification. When the inlay prints successfully, adjust one setting (print speed, tag saver, verification) at a time and resend the print job. Doing so makes it easier to resolve any errors if they occur.

The start encode position may need to be decreased or increased. The read power level may also need to be increased by 1. Call Technical Support. For detailed descriptions of error messages, refer to the *Packet Reference Manual*.

If an RFID error occurs when using Easy Setup, call Technical Support.

If an RFID error occurs when using stop-to-encode mode, call Technical Support.

This chapter explains the differences between online and offline printing.

Before printing

- ◆ load supply
- ◆ connect the printer to a host (a PC or a network)
- ◆ make sure the printer is ready to receive data.

Downloading Files

There are several ways to download files to the printer. Make sure the communication settings at the host match those at the printer.

Port	Connection
◆ Serial port	<p>Connect the printer to your PC with a serial cable. Use the Command prompt, terminal emulator (communications) software, such as Tera Term or our MPCL Toolbox software to download files.</p> <p>Command Prompt Example</p> <pre>COPY LABEL1.FMT COM1</pre> <p>Transmits a file called "LABEL1.FMT" to COM1.</p> <pre>COPY LABEL1.BCH COM1</pre> <p>Transmits a batch called "LABEL1.BCH" to COM1.</p> <p>If you use the COPY command to download your formats, set flow control to DTR (not XON/XOFF).</p>
◆ USB port	<p>Connect the printer to your PC with a USB cable. Use the Command prompt or terminal emulator (communications) software, such as Tera Term to download files.</p>
◆ Ethernet	<p>Connect the printer with an Ethernet cable and use MonarchNet2 or other software to download files.</p>
◆ 802.11 a/b/g/n network	<p>Connect to the printer using MonarchNet2™ or other software to download files. Refer to the <i>MonarchNet2 Operating Instructions</i> for more information.</p>

The printer accepts files in MPCLII, MLI, or XML format.

MPCLII files include configuration packets, formats, batches (print jobs), fonts, scripts, check digits, or graphics.

Online Printing

Online printing means the printer is connected to a host and ready to print data.

1. Design the format using the *Packet Reference Manual* or using label creation software.
2. Download a format and a batch to the printer.
3. The printer is ready to receive data when you see:

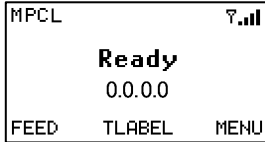

The printer prints the batch (print job).

Offline Printing

Offline printing means entering batch data from a keyboard and printing batches.

To print a format saved into flash memory that contains all fixed data:

1. Design the format to be saved *in flash memory* using the *Packet Reference Manual* or using label creation software.
2. Format flash memory. Any formats, graphics, and fonts saved in flash memory are erased. See "[Formatting Flash Memory](#)" for more information.
3. When you see "Ready," download the format.
4. From the Main menu, press → until you Data Entry. Press **ENTER**.
5. Press ← or → to select a format and press **SELECT**.

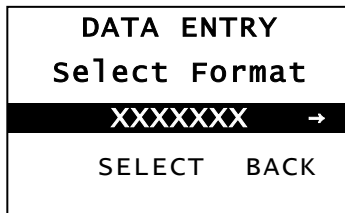

6. Answer the Data Entry Prompts:

Prompts	Choices	Default
Clear Fields?	Yes/No	No
Number of Parts	1 to 5	1
Print Multiple	1 to 32000	1
Quantity	1 to 32000	1
Print Now?	Yes/No	Yes

The printer prints the batch (print job).

If you change the speed *in offline mode*, turn off the printer then turn it back on before the change takes effect.

USING DIAGNOSTICS

This chapter explains how to view the printer’s version numbers, check supply quality, perform cutter maintenance, and enable a password.

For a complete list of printer error message, refer to the *Packet Reference Manual* on our Web site.

Factory Set Password

A password is required to access the diagnostic functions.



Press **Feed** three times and then press **Enter**.

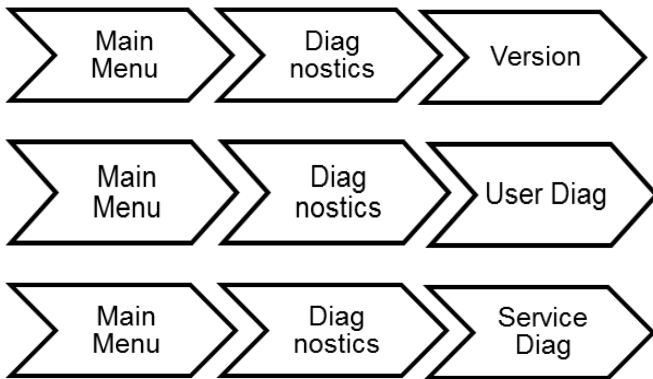

The Service Diagnostics menu can only be accessed by a Service Representative; it requires a separate password.

Option	Choices	Default
Version	Firmware/Serial Number/Board ID/Wireless/RFID 1/RFID 2/ Easy Setup/ Cutter	NA
Supply Quality	NA	NA
Password	No/Yes	No

Refer to the *Cutter’s Operating Instructions* or the *EcoCut Operating Instructions* for more information about your cutter.

Checking the Versions

View the version number of the printer's firmware, RFID module's firmware, and RFID inlay database. The printer's serial number is also viewable. View the printer's wireless module type.

Select	To
Firmware	View the printer's firmware version.
Serial Number	View the printer's serial number.
Board ID	View the control board's revision level.
Wireless	View the Wireless module type.
RFID 1	View the RFID module's version. This is the optional encoder.
RFID 2	View the RFID module's version. This is the optional external reader.
Easy Setup	View the database version number for the RFID inlay database, d46ESXX.db . Check our web site for updates. See " Updating the RFID Inlay Database " for more information
Cutter	View the cutter's version.

Checking Supply Quality

The printer continuously stores data from 16 of the most recently printed supplies to check the reflectivity of the sense marks on the supply. Before you check your supply quality, print a batch of supplies or test labels.

Select	To
Supply Quality	View the supply quality. The message "No data!" appears if you have not printed any labels. Press ← or → to display the readings.

USER DIAG			
Len	Min	Max	OK
1225	036	218	Y→
BACK			

Len	The length of the loaded supply in dots.
Max	Should always be greater than Min listing.
OK	Did the sense mark pass the detection test? Y or N

Using a Password

The password feature prevents formats, graphics or fonts from accidentally being deleted from the printer's memory. *It limits access to the Setup and Scripts menus by prompting for a password.*

Select	To
No	Disable the password. The password is not required to access the Setup and Scripts menus. "No" is the default password setting, therefore it is always shown even if password is enabled.
Yes	Enable the password. The password <i>is</i> required to access the Setup and Scripts menus. Enter the password: press FEED three times then ENTER .

When password protection is enabled, a password is not required to clear batches, but it is required to clear formats, graphics, and fonts.

This chapter includes troubleshooting information for network setup, adjusting the printer to remove ribbon wrinkle, and setting the ribbon's tension.

For more information about using MonarchNet2™ to configure the printer, refer to the *MonarchNet2 Operating Instructions*.

Configuring a Wireless Printer using a Wired Connection

Depending on the facility's network, you may need to use a wired connection to initially configure the wireless printer.

The ADTP1 printer has different IP addresses based on connection type: one for wired (Ethernet) and a different one for wireless connections. If no IP address appears on your printer, it indicates the DHCP request failed.

1. Connect an Ethernet cable to the printer.
2. Turn on the printer. Once the printer connects to the wired network, you see its IP address on the display.



3. Open your Web browser.
4. Type in your printer's IP address and press **Enter**.
5. Use MonarchNet2™ to configure the printer as needed. Refer to the *MonarchNet2 Operating Instructions* for more information.
6. Disconnect the Ethernet cable.
7. Turn off the printer. Wait two seconds, then turn on the printer. You may need to cycle the printer's power more than once before a wireless connection is established.
8. Once an IP Address appears, repeat steps 3 - 5. To verify a wireless connection, click Virtual Panel Display, and press **Feed**. The printer should feed a label.

Using the Network Console Packet

If you cannot connect the printer to your network using MonarchNet2 (or similar networking tool), try using a wired connection to configure the network printer. If that does not work, send console commands to the printer instead. The network console packet is written in MPCL and accepted through the printer's serial port.

Syntax {N,number,action,device,"name" |
C,"con_comds" | }

- N1. N* Network Console Packet.
- N2. number* Number from **0** to **999** to identify the network console packet. **1** is the default.
- N3. action* Action. Enter **A** to add a network console packet.
- N4. device* Storage device. Enter **T** to pass the packet through the printer and store the packet in the wireless module.
- N5. "name"* Packet name, **0** to **8** characters, enclose within quotation marks. "" is the default.
- C1. C* Append data.
- C2. "con_comds"* Console commands. Must be enclosed within quotation marks. "" is the default. Each command must be on a separate line. The maximum number of characters per command is 100. Refer to the complete list of console commands in the *MonarchNet2 Operating Instructions* for more information.
The maximum number of commands per packet is twenty five (25).

IP Address Example

{N,1,A,T,"protocol"	Names the packet <code>protocol</code>
C,"set ip me static"	Sets method to obtain IP address as static
C,"set ip add 192.0.0.192"	Sets IP address to 192.0.0.192
C,"set ip sub 255.255.0.0"	Sets Subnet Mask to 255.255.0.0
C,"set ip ro 192.0.0.1"	Sets IP Gateway to 192.0.0.1
C,"init"	Saves the settings and initializes the printer
C,"exit" }	Exits console mode

Wireless Example

{N,1,A,T,"wireless" 	Names the packet wireless
C,"set en ssid testprt" 	Sets wireless SSID to testprt
C,"set en enc WPA2" 	Sets wireless encryption mode to WPA2
C,"set en authtype PSK" 	Sets authentication type to PSK (pre-shared key)
C,"set en wpapsk KnockKnock" 	Sets the pass-phrase to KnockKnock
C,"init" 	Saves the settings and initializes the printer
C,"exit" }	Exits console mode

Adjusting the Printer to Remove Ribbon Wrinkle

Ribbon wrinkle appears as a void or blank line in the printed supply caused by a fold or wrinkle in the ribbon during printing.

Ribbon wrinkle may occur

- ◆ when the ribbon take-up core is loosely wrapped or contains folds. Rotate the take-up core until it is tight. If that does not help, load a new ribbon.
- ◆ when there is uneven pressure across the width of the printhead. Make sure the printhead pressure dials are set correctly. Refer to the printer's *Operator's Handbook*.
- ◆ if the supply roll guides and/or supply guides are not set correctly. Make sure the supply is loaded correctly.
- ◆ during normal printer operation. Adjust the ribbon's tension.

Ribbon Wrinkle



After ribbon adjustments,
no ribbon wrinkle

About the Ribbon's Take-up Reel

Rotate the take-up reel until the ribbon is tight under the printhead and no wrinkles are visible.

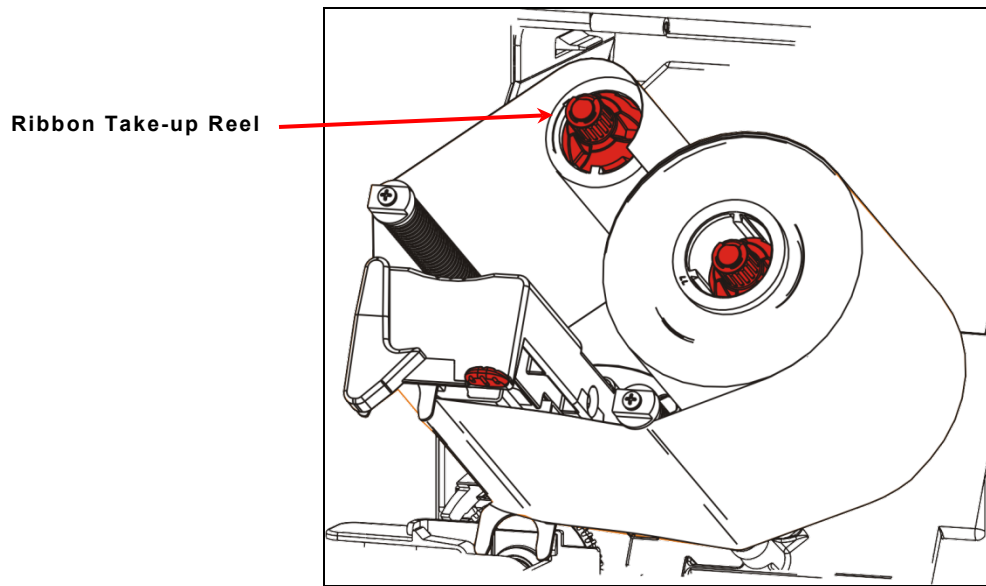

Setting the Supply Guides

1. Adjust the roll guides to fit your supply roll and place rolled supply on the holder. The supply roll must move freely.

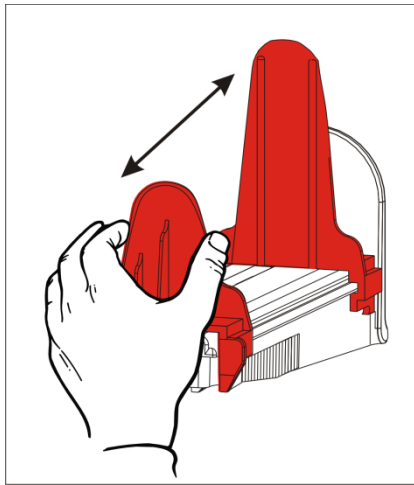

2. Unlock the supply guides and feed the supply through the supply path so a few inches extend past the front of the printer. Tuck the supply under the nibs and die cut sensor.

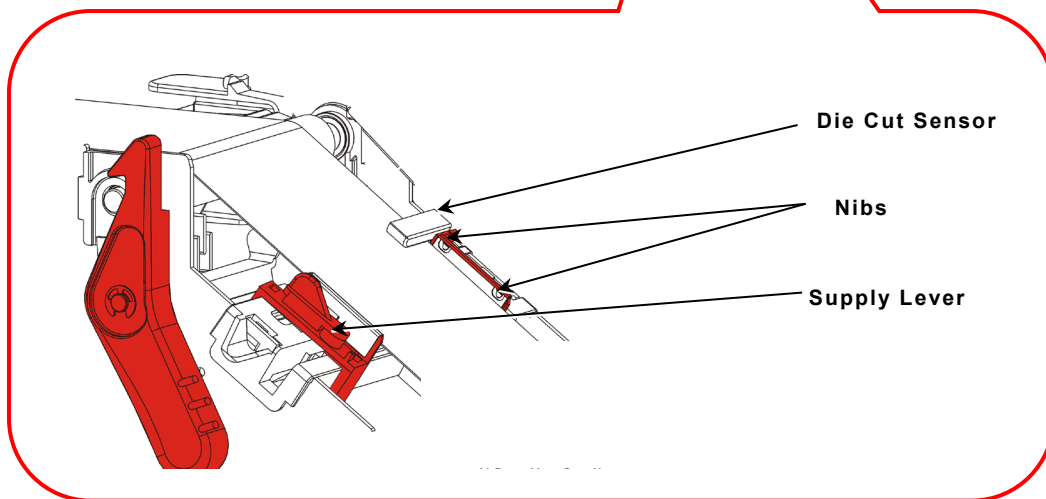
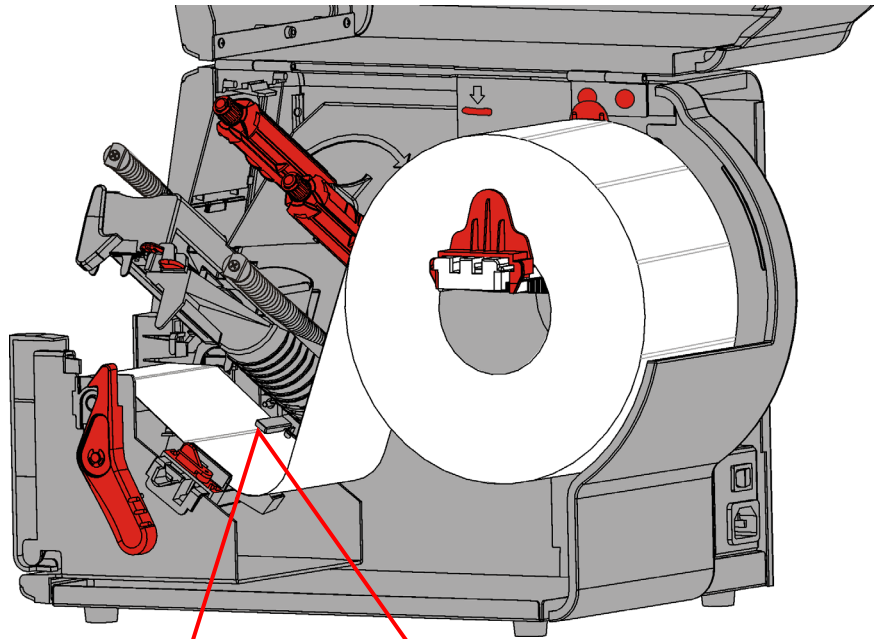

3. Adjust the supply guides so they barely touch the supply. Turn the supply lever up to lock it in place.

Adjusting the Ribbon Tension

Rotate the ribbon take-up guide to adjust for even tension across the width of the ribbon. This adjustment moves the outside end of the ribbon roller to change the pressure on the ribbon. A properly adjusted ribbon provides consistent ribbon tracking and reduced opportunity for ribbon wrinkles.

Use a Phillips head screw driver.

1. Load 4-inch wide thermal transfer supply with a 4-inch wide ribbon.
2. Set the printhead pressure dials to an equal setting.
3. Loosen the locking screw on the end of the ribbon take-up guide, set the guide at the nominal position.

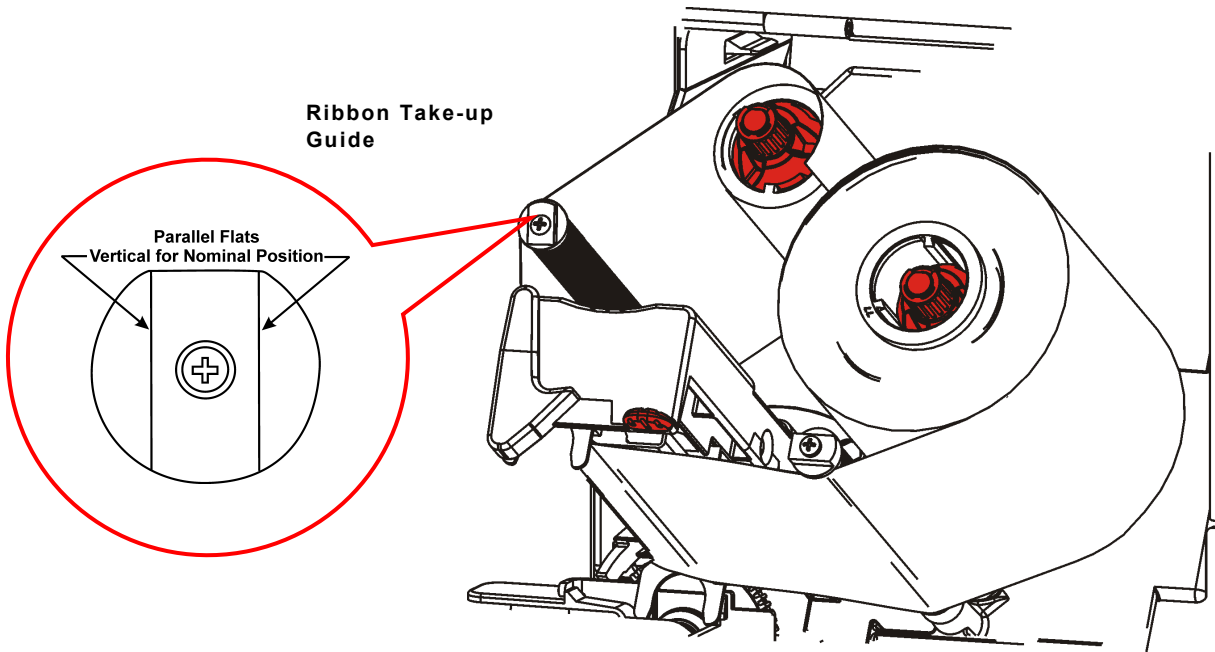

4. Print several labels and check for ribbon wrinkle. If necessary, turn the guide clockwise to increase tension. Print several labels and check for even tension across the ribbon with no creases or wrinkles.
5. Hold the ribbon take-up guide and tighten the screw.

If wrinkles occur again, repeat the adjustment.

If print quality does not improve, a service adjustment may be necessary. Contact Technical Support.

SPECIFICATIONS & ACCESSORIES



For printer and supply specifications, refer to the *Operator's Handbook*.

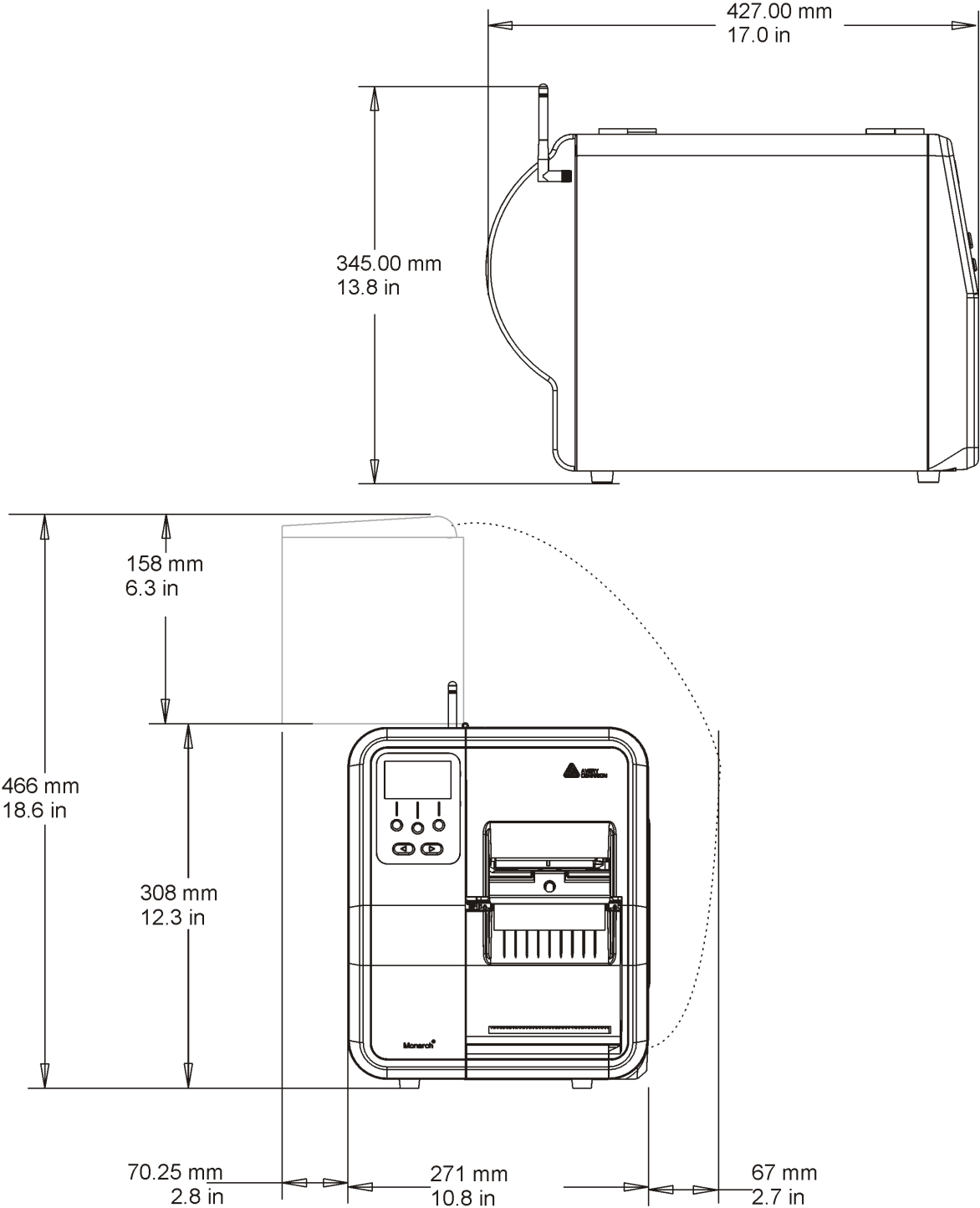

Supplies (Media)

String Tags

Widths:	0.90 inches (23 mm) minimum 2.0 inches (51 mm) maximum
Lengths:	0.78 inch (20 mm) minimum 2.0 inches (50 mm) maximum
Thickness:	5.6 to 14 mils
String Loop Length:	0.63 inches (15.8mm) minimum 1.5 inches (38 mm) maximum
String Orientation:	Facing operator
Wind Direction:	Face out

Cable Pinouts

The following tables show the connector pins for the serial 9-pin to 9-pin (126716) cable.

9-Pin (M)	To	9-Pin (F)
SHIELD		SHIELD
1		1
RCV 3		3 RCV
TX 2		2 TX
CTS 6		6 CTS
RTS 4		4 RTS
DTR 8		8 DTR
DSR 7		7 DSR
+5V 9		9 +5V
SGND 5		5 SGND

Accessories

- ◆ 935™ External Rewind
- ◆ Supply Guide Extension (131438)
- ◆ USB cable (126738)
- ◆ 203 dpi (128933ST) printhead
300 dpi (130226) printhead
- ◆ Printhead CLEAN-STRIP (120350)
- ◆ USB mini keyboard (160001)
- ◆ Tear Bar (131439)
- ◆ Serial Cable: 9-pin to 9-pin (126716)
- ◆ *Packet Reference Manual* –
Programmer's manual (TCADTP2PR)
- ◆ Printhead Cleaning Pen (114226)

Factory-Installed Options

- ◆ Internal Ethernet with
MonarchNet2™
- ◆ Peel mode
- ◆ Cutter Ready
- ◆ RFID Encode
- ◆ 300 dpi printhead
- ◆ 802.11a/b/g/n wireless with
MonarchNet2™
- ◆ Peel mode with internal liner take-up
- ◆ Cart Ready for use on Mobile
Workstation
- ◆ RFID Encode and Verify
(not available with peel mode)
- ◆ ADK script programming for special
applications

Shipping the Printer

If you need to ship the printer to a different location and do not have the original packaging, use the following part numbers to order the appropriate packaging materials.

2. Remove the ribbon roll, if one is loaded.
3. Remove the supply roll, if one is loaded.
4. Close the printhead by pressing down on the thumb well until it clicks into place.
5. Place the printer in the original box and secure with packaging material. Make sure the printer is adequately packed to avoid damage during shipment.

Part Number	Description and (Qty.)	Part Number	Description and (Qty.)
70101	Shipping carton (1)	70704	Foam, Top Pad (1)
70702	Tray (1)	70705	Interlock, Hand Hole (4)
70703	Foam, Bottom Pad (1)	00054301	Poly Bag (1)

MENU STRUCTURE



Use the Function button to select MENU. Then, use ← or → to scroll through options. Press **SELECT** when you see the menu option you need.

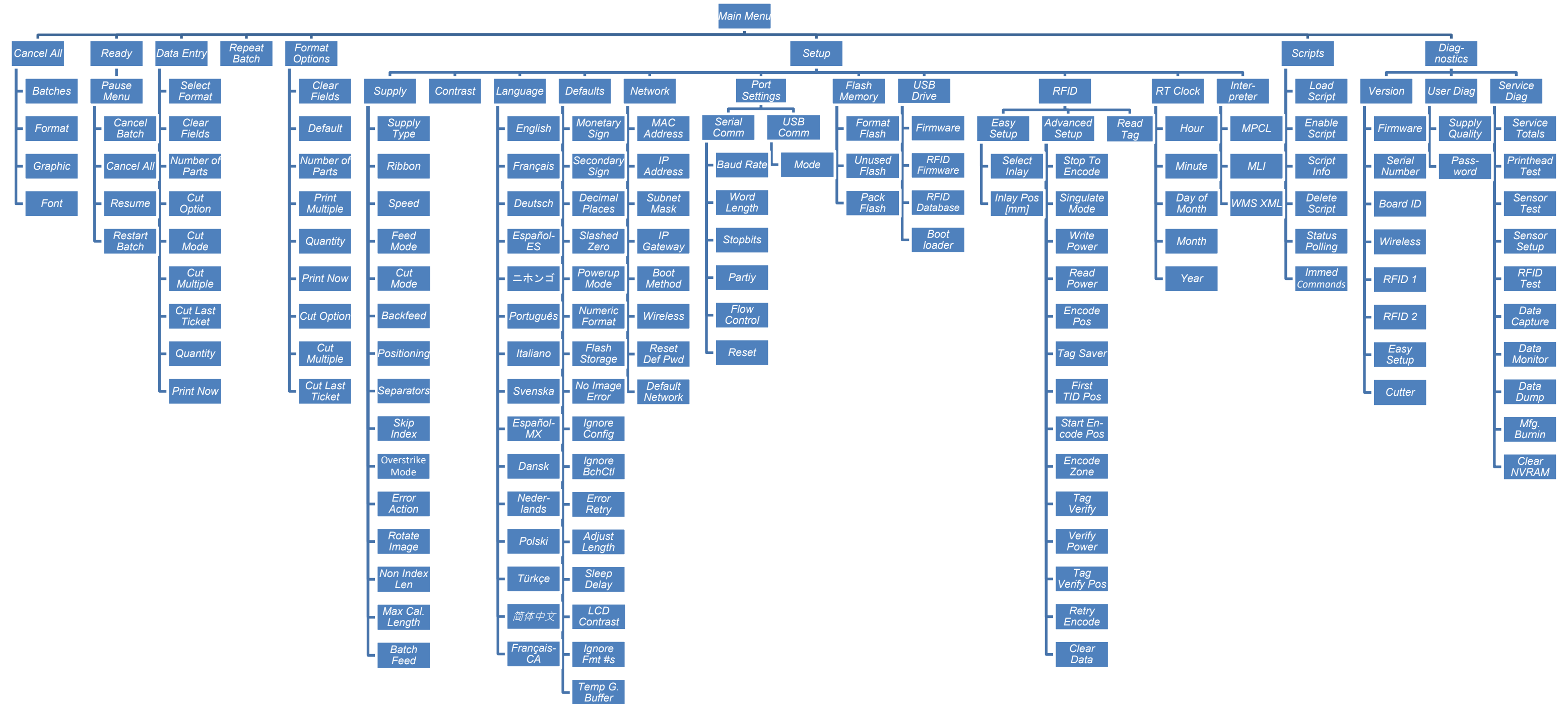

Supply Menu

Use the Function button to select MENU. Then, use ← or → to scroll through options. Press **SELECT** when you see the menu option you need.

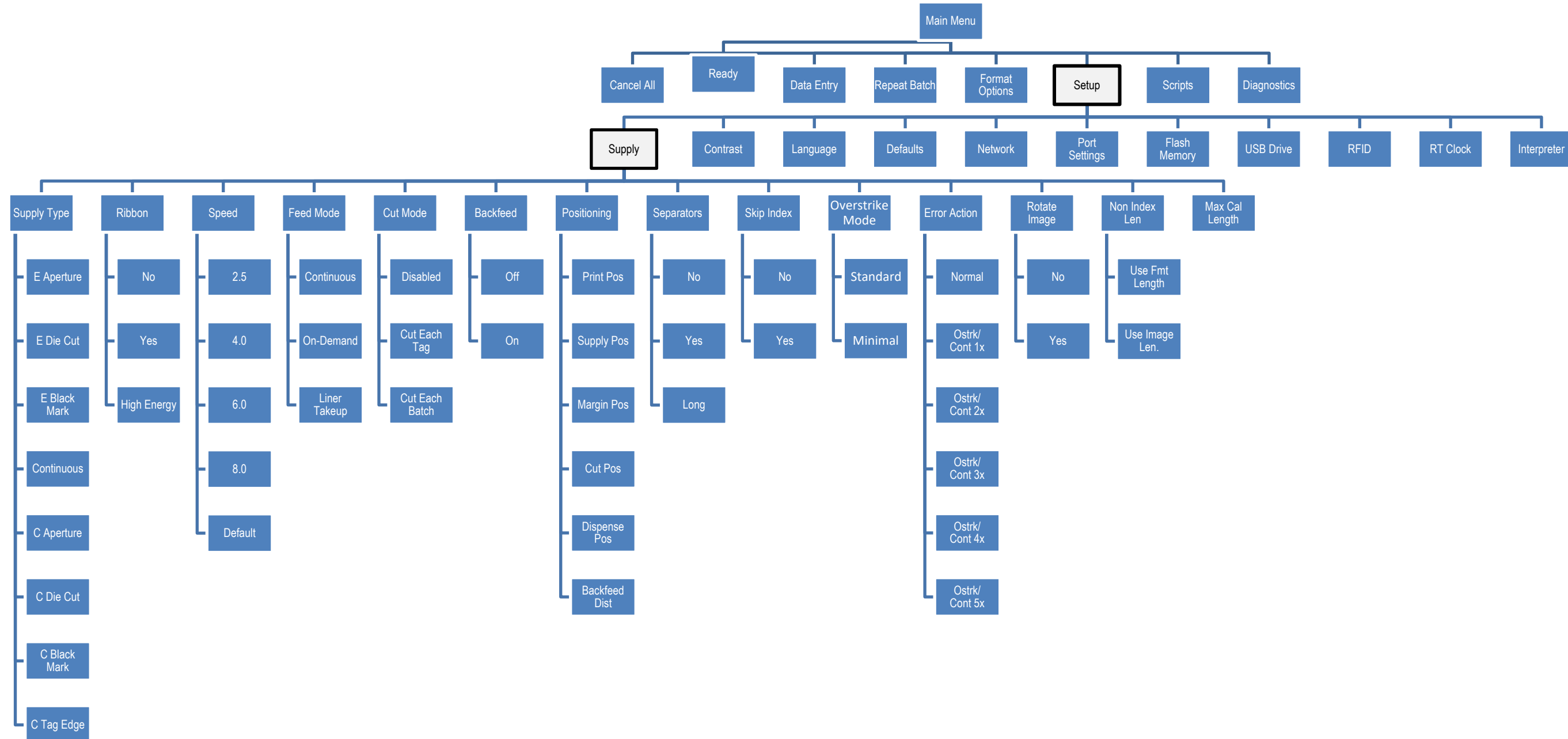

GLOSSARY

The following terms will help you use this manual.

continuous mode	The printer prints all the labels in the job (batch) without stopping.
download (send)	Transmission of data from the host to your printer.
EPC	The Electronic Product Code, which is a numbering standard for items, similar to the UPC code for bar coding. The EPC is divided into several sections: Header, Manager Number, Object Class, and Serial Number. The amount of EPC memory varies with the inlay types. Used for RFID programming.
format	Supply layout or design that is downloaded to the printer.
host	Any mainframe, minicomputer, data collect terminal, or personal computer sending data to the printer.
inlay	A type of media that contains a transponder and is converted for use in Monarch® RFID supplies (tags). Inlays can be made with different types of transponders.
interrogator	The electronics module that programs the RFID inlays through the antenna.
LCD	Display on the printer used to indicate printer conditions and problems.
leader	Wrap around a new roll of ribbon with printing on it.
Liner take-up mode	The printer collects the backing paper (liner) on a reel after the label is printed.
on-demand mode	The printer stops after each label is printed for removal and application before printing the next label.
peel mode	The printer separates the backing paper (liner) from the label after printing.
print job (batch)	Actual data printed on a label or tag. The host may download the print job together with the format, or as a separate packet. The print job is also called a "batch."
offline mode	The printer does not need a connection to a host to print.
online mode	The printer requires a connection between a network/computer to print.
read power	Increase or decreases the strength of the RF field emitted by the printer's antenna to read a programmed inlay.
RFID inlays	Supplies that contain an embedded programmable chip and antenna.
supply sensor	Senses whether supply is loaded or needs to be loaded in the printer. Located in the supply path.

supplies	Labels and tags used for printing.
TID	The Transponder Identification Number, which contains the chip type, features, and available custom commands supported for tag authentication.
transponder	The combination of the embedded programmable chip with an antenna on some type of media (film, paper, etc.).
write power	Increase or decreases the strength of the RF field emitted by the printer's antenna to program the inlay.



AMERICAS

170 Monarch Lane
Miamisburg, OH 45342
937 865 2123 (direct)
Tel +800 543 6650
(8:00 a.m. – 6:30 p.m., EDT)
Fax +937 865 6663

ASIA

No. 7 Chun Ying Street
Tseung Kwan O Industrial Estate
New Territories, Hong Kong
Tel +852 2372 3169
Fax +852 2995 0014

WESTERN EUROPE

Unit 5, Elia Close.
Chapel Lane.
High Wycombe. HP12 4FX. UK
Tel +(44) 1628 859500
Fax +(44) 1628 859567

ASIA PACIFIC

NEW SOUTH WALES

61 Vore Street
Silverwater NSW 2128
Tel +(02) 9647 1833
Fax +(02) 9647 1914
Toll free (Outside Sydney only)

<https://identificationsolutions.averydennison.com/>